



*In-depth investigations of accidents involving
powered two wheelers*

Final Report 1.1

Acknowledgements

The collection and analysis of the MAIDS research project data would not have been possible without the active support and contribution of the following people:

- The President and Members of the European Motorcycle Manufacturers Association for their support and leadership during all phases of this research project.
- The European Commission and the Director General of Transportation and Energy for their support of motorcycle safety research in Europe.
- The MAIDS Project Partners (see Annex A)
- Members of the MAIDS Management Group and MAIDS Expert Group (see Annex A)
- All the members of the five MAIDS research teams (see Annex A). These are the people who worked long hours to conduct scene investigations, vehicle inspections, witness interviews and gather medical information. It is these people who collected, analyzed and coded all the data that is presented in this report. Without their efforts and their continuous dedication to the goal of reducing the frequency and severity of PTW accidents in Europe, this report would not have been possible.
- All the police, government and medical groups and agencies that provided support to the research teams, without which, the MAIDS could not have been collected.
- Mr. Federico Galliano, former Secretary General of ACEM for his commitment in time and energy to the coordination of the first multi-country motorcycle accident study in Europe to use the OECD Common Methodology.
- Dr. Alessandra Marinoni, Dr. Mario Comelli and their students at the University of Pavia for their assistance with the creation and analysis of the MAIDS database.
- Mr. Thomas Goetz for his leadership of the MAIDS Expert Group and his assistance with the data analysis.
- Dr. Terry Smith for his assistance in team training, quality control and the editing of the final report.
- Dr. Nick Rogers for his guidance and insight in developing the Inter-team Workshops as a tool for harmonizing the implementation of the OECD Common Methodology.
- Mr. Paul Caille for his coordination efforts during the preliminary development of this research project.

And a special thanks to all the PTW riders, passengers and OV drivers who volunteered information about themselves and about their accidents so that other PTW riders might benefit.

Table of contents

Acknowledgements	2
Table of contents	3
1.0 Executive Summary	9
2.0 Objectives and methodology	11
<i>Sampling areas</i>	11
<i>Exposure data</i>	12
<i>Accident data collection</i>	12
<i>Accident reconstruction</i>	14
<i>Quality control</i>	15
<i>Explanation of legal categories and PTW styles</i>	15
<i>Explanation of data presentation</i>	20
<i>Statistical tests</i>	21
3.0 General accident characteristics	22
4.0 Accident causation	28
4.0 Accident causation	29
<i>Human contributing factors</i>	31
<i>Environmental contributing factors</i>	36
<i>Vehicle contributing factors</i>	40
<i>Findings on accident causation</i>	42
5.0 Vehicles	43
<i>Vehicle characteristics</i>	43
<i>Collision dynamics</i>	47
<i>Vehicle technical conditions at the time of accident</i>	68
<i>Findings on Vehicles</i>	69
6.0 Environmental factors	71
<i>Roadway types and condition</i>	71
<i>Traffic controls</i>	75
<i>Findings on environmental factors</i>	76
7.0 Human factors	77
<i>Findings on human factors</i>	93
8.0 Powered two wheelers in a mixed traffic environment	95
<i>Visibility</i>	95
<i>Lighting and conspicuity</i>	98
<i>Findings on powered two wheelers in a mixed traffic environment</i>	101
9.0 Rider protection	102
<i>PTW Rider injury</i>	104
<i>PTW passenger injury</i>	114
<i>Injury and impact speed</i>	117

<i>The effect of a passenger</i>	118
<i>Helmets</i>	118
<i>Clothing</i>	122
<i>Findings on rider protection</i>	128
10.0 Rationale for action	129
References	131
Glossary	132
Annex A	135
Annex B	138
Annex C	140

List of figures

Figure 2.1:	Conventional street style PTW	16
Figure 2.2:	Sport style PTW.....	17
Figure 2.3:	Cruiser style PTW.....	17
Figure 2.4:	Chopper style PTW	18
Figure 2.5:	Touring style PTW	18
Figure 2.6:	Scooter style PTW.....	19
Figure 2.7:	Step-through style PTW	19
Figure 2.8:	Sport Touring style PTW	20
Figure 2.9:	Enduro style PTW.....	20
Figure 2.10:	Illustration of sample cross-tabulation and how to read a cross-tabulation	21
Figure 3.1:	PTW collision partner by type of area	25
Figure 3.2:	Time of day accident occurred	26
Figure 3.3:	Month in which accident occurred	27
Figure 3.4:	PTW accident configuration by legal category	28
Figure 4.1:	Detailed primary accident contributing factors	30
Figure 5.1:	PTW style	44
Figure 5.2:	PTW style by legal category	44
Figure 5.3:	Comparison of travelling speed for fatal and non fatal cases (all accidents)	51
Figure 5.4:	Travelling speed (all accidents).....	51
Figure 5.5:	OV travelling speed (all accidents).....	53
Figure 5.6:	PTW line of sight to OV	55
Figure 5.7:	OV line of sight to PTW	57
Figure 5.8:	Relative heading angle	61
Figure 5.9:	Distribution of relative heading angles for PTW to OV collisions	62
Figure 6.1:	Roadside barrier injury summary.....	75
Figure 7.1:	PTW rider age.....	78
Figure 7.2:	PTW rider age by PTW legal category	79
Figure 7.3:	Cross-tabulation of PTW rider age by primary accident contributing factor	79
Figure 7.4:	PTW rider age by primary accident contributing factor (L1 vehicles).....	80
Figure 7.5:	PTW rider age by primary accident contributing factor (L3 vehicles).....	81
Figure 7.6:	PTW travelling speed by PTW rider age	82
Figure 7.7:	PTW impact speed by PTW rider age	83
Figure 7.8:	Cross-tabulation of primary accident contributing factor by OV driver's licence qualification	84
Figure 7.9:	Riding experience on any PTW	86
Figure 7.10:	Riding experience on vehicle in use at time of accident or exposure survey.....	87
Figure 7.11:	Riding experience on accident PTW	88
Figure 7.12:	PTW rider experience on any PTW.....	88
Figure 7.13:	Cross-tabulation of primary accident contributing factor by riding experience on any PTW.....	89
Figure 7.14:	PTW collision avoidance manoeuvre by PTW training.....	91
Figure 7.15:	Cross-tabulation of PTW rider experience by identification of skill deficiency as a contributing factor...	93
Figure 9.1:	PTW first collision contact code.....	103
Figure 9.2:	OV first collision contact code	104
Figure 9.3:	Summary of distribution of PTW rider injuries greater than AIS=1	106
Figure 9.4:	Cross-tabulation of rider MAIS by body region.....	107
Figure 9.5:	Distribution of rider head MAIS by collision contact code	108
Figure 9.6:	Distribution of rider neck MAIS by collision contact code.....	119
Figure 9.7:	Distribution of rider upper extremity MAIS by collision contact code	110
Figure 9.8:	Distribution of rider thoracic MAIS by collision contact code.....	110
Figure 9.9:	Distribution of rider abdominal MAIS by collision contact code.....	111
Figure 9.10:	Distribution of rider pelvic MAIS by collision contact code	112
Figure 9.11:	Distribution of rider spine MAIS by collision contact code.....	113
Figure 9.12:	Distribution of rider lower extremity MAIS by collision contact code	114
Figure 9.13:	Summary of distribution of PTW passenger injuries greater than AIS=1	116
Figure 9.14:	Cross-tabulation of passenger MAIS by body region.....	117
Figure 9.15:	Cross-tabulation of rider MAIS by PTW impact speed.....	117
Figure 9.16:	Cross-tabulation of helmeted rider's head MAIS and PTW impact speed	122
Figure 9.17:	Distribution of PTW rider clothing	126
Figure 9.18:	Distribution of PTW passenger clothing	127

List of tables

Table 3.1:	Total number of cases collected	22
Table 3.2:	Number of fatal cases	22
Table 3.3:	PTW legal category	22
Table 3.4:	PTW collision partner	23
Table 3.5:	Number of OV's involved in the accident	23
Table 3.6:	Number of passengers on PTW	23
Table 3.7:	Number of passengers on PTW (fatal accidents only)	24
Table 3.8:	Accident scene, type of area	24
Table 3.9:	Accident location	25
Table 3.10:	Day of week accident occurred	26
Table 4.1:	Primary accident contributing factor	29
Table 4.2:	Other accident contributing factors	31
Table 4.3:	Attention failure, including distractions and stress (PTW rider)	32
Table 4.4:	Attention failure, including distractions and stress (OV driver)	32
Table 4.5:	Traffic-scan error (PTW rider)	32
Table 4.6:	Traffic-scan error (OV driver)	33
Table 4.7:	Visual obstructions neglected (PTW rider)	33
Table 4.8:	Visual obstructions neglected (OV driver)	33
Table 4.9:	Temporary traffic hazard detection failure (PTW rider)	34
Table 4.10:	Temporary traffic hazard detection failure (OV driver)	34
Table 4.11:	Faulty traffic strategy (PTW rider)	34
Table 4.12:	Faulty traffic strategy (OV driver)	35
Table 4.13:	Speed compared to surrounding traffic (PTW)	35
Table 4.14:	Speed compared to surrounding traffic (OV)	35
Table 4.15:	Roadway design defect (PTW)	36
Table 4.16:	Roadway design defect (OV)	37
Table 4.17:	Roadway maintenance defect (PTW)	37
Table 4.18:	Roadway maintenance defect (OV)	38
Table 4.19:	Traffic hazard, including construction and maintenance operations (PTW)	38
Table 4.20:	Traffic hazard, including construction and maintenance operations (OV)	38
Table 4.21:	Traffic controls defect or malfunction (PTW)	39
Table 4.22:	Traffic controls defect or malfunction (OV)	39
Table 4.23:	Weather related problem (PTW)	40
Table 4.24:	Weather related problem (OV)	40
Table 4.25:	PTW vehicle failure, accident cause related problem	40
Table 4.26:	Specific cause of PTW vehicle failure, accident cause related problem	41
Table 4.27:	Fuel leakage	41
Table 4.28:	Fire occurrence	41
Table 4.29:	Specific cause of OV failure, accident cause related problem	42
Table 5.1:	PTW gross mass	45
Table 5.2:	PTW gross mass by PTW legal category	45
Table 5.3:	Engine displacement	46
Table 5.4:	Engine displacement by PTW legal category	46
Table 5.5:	Predominating PTW colour	47
Table 5.6:	Brake system configuration	47
Table 5.7:	PTW pre-crash motion prior to precipitating event	49
Table 5.8:	OV pre-crash motion prior to precipitating event	50
Table 5.9:	PTW travelling speed (single vehicle accidents)	52
Table 5.10:	PTW travelling speed (single vehicle accidents excluded)	52
Table 5.11:	OV travelling speed	53
Table 5.12:	PTW pre-crash motion after precipitating event	54
Table 5.13:	OV pre-crash motion after to precipitating event	56
Table 5.14:	PTW impact speed	58
Table 5.15:	PTW impact speed - single vehicle accidents only	58
Table 5.16:	PTW impact speed (single vehicle accidents excluded)	59
Table 5.17:	OV impact speed (all accidents)	59
Table 5.18:	Travelling and impact speeds for moped accidents	60
Table 5.19:	Travelling and impact speeds for PTW accidents	60
Table 5.20:	Collision avoidance performed by PTW rider	63

Table 5.21:	Loss of control mode (PTW rider)	63
Table 5.22:	Loss of control mode (single vehicle accidents)	64
Table 5.23:	Reason for failed collision avoidance	65
Table 5.24:	Control unfamiliarity (PTW rider)	65
Table 5.25:	Collision avoidance manoeuvre performed by OV driver	65
Table 5.26:	Post crash motion of the PTW	66
Table 5.27:	Post crash motion, PTW rider motion	66
Table 5.28:	Post crash passenger motion code	67
Table 5.29:	Post crash OV motion	67
Table 5.30:	L1 vehicle tampering	68
Table 5.31:	Symptom of PTW problem	68
Table 5.32:	OV mechanical problem	69
Table 6.1:	Roadway type	71
Table 6.2:	Roadway alignment (PTW)	72
Table 6.3:	Roadway alignment (OV)	72
Table 6.4:	Weather conditions at time of accident	72
Table 6.5:	Roadway contamination	73
Table 6.6:	Roadway condition and defects	73
Table 6.7:	Roadway condition and defects (fatal accidents only)	73
Table 6.8:	Roadway condition	74
Table 6.9:	Traffic controls along PTW pre-crash path	75
Table 6.10:	Traffic control violated by PTW rider	76
Table 6.11:	Traffic controls along OV pre-crash path	76
Table 6.12:	Traffic controls violated by OV operator	76
Table 7.1:	PTW rider gender	77
Table 7.2:	PTW rider gender by PTW legal category	77
Table 7.3:	OV driver age	83
Table 7.4:	OV driver licence qualification	84
Table 7.5:	PTW licence qualification	85
Table 7.6:	Licence qualification for vehicle in use at time of accident or exposure survey	85
Table 7.7:	PTW training	90
Table 7.8:	Cross-tabulation of PTW training by PTW legal category	90
Table 7.9:	Alcohol/ drug use by PTW rider	92
Table 7.10:	Alcohol/drug use by the OV driver	92
Table 7.11:	Skills deficiency (PTW rider)	92
Table 7.12:	Skills deficiency (OV driver)	93
Table 8.1:	Visibility limitation (PTW rider)	95
Table 8.2:	Visibility limitation (OV driver)	96
Table 8.3:	Stationary view obstructions for PTW rider	96
Table 8.4:	Mobile view obstructions for PTW rider	97
Table 8.5:	Stationary view obstructions for OV driver	97
Table 8.6:	Mobile view obstructions for OV driver	97
Table 8.7:	Traffic density at time of accident (PTW)	98
Table 8.8:	Traffic density at time of accident (OV)	98
Table 8.9:	Illumination at time of accident	99
Table 8.10:	Headlamp(s) in use at time of accident?	99
Table 8.11:	Visual background of OV along PTW rider's line-of-sight at time of precipitating event (PTW)	100
Table 8.12:	Visual background of PTW along the OV driver's line-of-sight at time of precipitating event	100
Table 8.13:	Contribution of PTW rider clothing to conspicuity	101
Table 9.1:	PTW rider trauma status	105
Table 9.2:	PTW passenger trauma status	114
Table 9.3:	Passenger contribution to accident causation	118
Table 9.4:	Effect of rider/passenger interaction on injury causation	118
Table 9.5:	Rider helmet usage	119
Table 9.6:	Cross-tabulation of PTW rider helmet usage by PTW legal category	119
Table 9.7:	Rider helmet type	119
Table 9.8:	Effect of helmet upon head injury (PTW rider)	120
Table 9.9:	Passenger helmet usage	120
Table 9.10:	Passenger helmet type	120
Table 9.11:	Rider helmet retention	121
Table 9.12:	Cause of rider helmet ejection	121
Table 9.13:	Cause of passenger helmet ejection	121

Table 9.14:	Effect of PTW rider upper torso clothing on injury	122
Table 9.15:	Effect of PTW passenger upper torso clothing on injury	123
Table 9.16:	Effect of PTW rider lower torso clothing on injury	123
Table 9.17:	Effect of PTW passenger lower torso clothing on injury	123
Table 9.18:	Effect of PTW rider footwear on injury	124
Table 9.19:	Effect of PTW passenger footwear on injury	124
Table 9.20:	Effect of gloves on PTW rider injury	124
Table 9.21:	Effect of gloves on PTW passenger injury	125

1.0 Executive Summary

In these days of increasing congestion on our roads, powered two wheelers (PTWs)¹ continue to provide a valuable contribution to mobility in Europe. Their relatively small size and low cost enable them to blend efficiently into the traffic flow while needing less space compared to other vehicles (OVs). However, PTW riders form one of the most vulnerable groups of road users and road accidents involving injuries to them are a major social concern. It is therefore essential that all parties work together to understand and further improve the safety of this valuable mode of transport.

In order to better understand the nature and causes of PTW accidents better, the Association of European Motorcycle Manufacturers (ACEM) with the support of the European Commission and other partners conducted an extensive in-depth study of motorcycle and moped accidents during the period 1999-2000 in five sampling areas located in France, Germany, Netherlands, Spain and Italy. The methodology developed by the Organisation for Economic Co-operation and Development (OECD) for on-scene in-depth motorcycle accident investigations was used by all five research groups in order to maintain consistency in the data collected in each sampling area.

A total of 921 accidents were investigated in detail, resulting in approximately 2000 variables being coded for each accident. The investigation included a full reconstruction of the accident; vehicles were inspected; witnesses to the accident were interviewed; and, subject to the applicable privacy laws, with the full cooperation and consent of both the injured person and the local authorities, pertinent medical records for the injured riders and passengers were collected. From this data, all the human, environmental and vehicle factors which contributed to the outcome of the accident were identified.

To provide comparative information on riders and PTWs that were not involved in accidents in the same sample areas, data was collected in a further 923 cases. The collection technique was specifically developed to meet the circumstances of this study and is commonly referred to as an exposure or case-control study. This exposure information on non-accident involved PTW riders was essential for establishing the significance of the data collected from the accident cases and the identification of potential risk factors in PTW accidents. For example, if 20% of non-accident involved PTWs in the sampling area were red, it would be significant if 60% of those PTWs involved in an accident were reported to be red, suggesting that there is an increased risk of riding a red PTW. On the other hand, if none of the PTWs in the accident sample were red, it would be an interesting finding, needing further study.

The PTW accident data collected in this study indicated that the object most frequently struck in an accident was a passenger car. The second most frequently struck object was the roadway itself, either as the result of a single vehicle accident or of an attempt to avoid a collision with an OV. Whilst each sampling area contained both urban and rural areas, the majority of the accidents took place in an urban environment.

Travelling and impact speeds for all PTW categories were found to be quite low, most often below 50 km/h. There were relatively few cases in which excess speed was an issue related to accident causation.

¹ The term "powered two-wheeler" includes all types of road motorcycles, mopeds and mopas.

The cause of the majority of PTW accidents collected in this study was found to be human error. The most frequent human error was a failure to see the PTW within the traffic environment, due to lack of driver attention, temporary view obstructions or the low conspicuity of the PTW.

Once all the data had been collected, it was entered into a database for each sampling area and compared with the exposure data referred to above. Statistical analysis identified PTW accident risk factors by comparing the accident data to the exposure data.

Thus, for example, the exposure data indicated that whilst scooters represented the majority of accident cases, scooters were not over-represented in accidents in comparison with their presence in the sampling area (i.e., their exposure).

When the accident riders were compared to the exposure population, the data demonstrated that the use of alcohol increased the risk of being in an accident, although the percentage was lower than in other studies.

Unlicensed PTW operators who were illegally riding PTWs that required a licence, were also found to be at greater risk of being involved in an accident when compared to licenced PTW riders.

The data collected during this study represents the most comprehensive in-depth data currently available for PTW accidents in Europe. It is expected that this data will provide much needed information for developing future research in relation to public policy issues. Recommendations for future countermeasures and investigations are provided.

2.0 Objectives and methodology

Objectives

There is little detailed information about the casualties and accidents associated with powered two wheelers (PTW) in Europe. The information currently available comes from national police reports or from specific studies. National police reports are not sufficiently detailed to understand the causes of PTW accidents fully. Specific research studies of PTWs use different data collection criteria and different data collection methodologies, thereby limiting the ability to compare the different studies and to develop a comprehensive European strategy for the reduction of PTW accidents.

Previous in-depth research into PTW accidents has been conducted in North America (Hurt et al., 1981, Newman et al., 1974) as well as in the United Kingdom and Europe (Pedder et al., 1979, Otte et al., 1998). All of these studies have shown the need for in-depth investigations in order to provide a clear, detailed and objective analysis of the causes and consequences of PTW accidents. This in-depth PTW research has also shown the need to collect information regarding the non-accident PTW/rider population (i.e., a control population) in order to determine the relative risk of a given PTW/rider factor.

With the support of the European Commission and other partners, the Association of European Motorcycle Manufacturers (ACEM) conducted an extensive in-depth study of motorcycle and moped accidents in five European countries: France, Germany, Netherlands, Spain and Italy.

The objectives of this study were as follows:

1. To identify and indicate the causes and consequences of PTW accidents in a well-defined sampling area.
2. To compare the accident data to a control population in order to determine the risk associated with certain factors (e.g., alcohol).
3. To apply this comprehensive and reliable data source in the development of proper counter-measures that will reduce the frequency and severity of PTW accidents.

The same methodology for on-scene in-depth motorcycle accident investigations, developed by the Organisation for Economic Co-operation and Development (OECD), was used by all five research groups in order to maintain consistency in the data collected in each region. A complete description of this methodology is presented in the ACEM report titled "MAIDS Report on Methodology and Process" (ACEM, 2003).

Methodology

Sampling areas

The objective of MAIDS was to do a European study on PTW accidents. That is why 5 countries and five regions were selected, which altogether were felt to give a representative view of the PTW accident scene. Each sampling area was handled by a team under contract to the study's administration. A total of 921 in-depth accident investigations were conducted within these five sampling areas and used to form the aggregate database. Furthermore, the use of a case control study methodology allowed

for the analysis of risk factors and identification of potential countermeasures based upon the data collected from these five sampling areas. The analysis therefore focuses on the European dimension. The results of such a study can be compared with national statistics and other studies when assessing the implications.

Exposure data

In order to identify potential risk factors associated with PTW operation or use, it was necessary to compare the accident data with the characteristics of the PTW/rider population riding within each sampling area. This is referred to as a case control study wherein the cases (i.e., the accidents) are compared with an identical non-accident population (i.e., the circulating riding population within the sampling area). Statistical comparisons of the characteristics of this PTW/rider population and the accident population provide a method of estimating whether or not a risk factor (e.g., PTW style) is over or under-represented in the accident database and whether or not there is greater or less risk of being in an accident if that risk factor is present. It was the objective of this study to identify and examine as many of these risk factors as possible. This methodology has been used successfully in previous in-depth motorcycle accident studies (Hurt et al., 1980, Haworth et al., 1997).

From the statistical point of view, the validity of the exposure data, based on the population of riders and PTWs at risk in the accident sampling area, was given by sampling the same number of cases as selected for sampling the accidents: i.e., one control case had to be collected for each accident case. The collection of additional control cases would not have increased the statistical reliability or power of the data and therefore, one control case was sufficient (Breslow and Day, 1980). Video surveillance of PTWs moving through the accident scene one week after the accident was considered as a potential method of collecting vehicle information and a very limited amount of rider information. Unfortunately, this method provided none of the human factor data critical to understanding the human contribution to accident risk. Furthermore, stopping PTW riders on the roadway was against the law in some areas as well as a logistical challenge; therefore, an alternative methodology had to be developed.

An alternative control data collection method was developed by the University of Pavia research team. The method involved conducting PTW rider interviews and PTW inspections at randomly selected petrol stations within the sampling area. This petrol station methodology provided both the human and vehicle control data necessary to estimate the relative risk of a given factor using standard statistical procedures. A total of 923 PTW riders were interviewed using the petrol station methodology and each rider responded to over 200 human factor and vehicle questions. Each of these responses was entered into a database that was forwarded to the University of Pavia.

Accident data collection

Each accident was investigated in detail, resulting in approximately 2000 variables for each accident case. Cooperative agreements were established with local regulatory agencies (e.g., police and hospitals) within each of the sampling areas. This maximized the amount of information which could be obtained during the in-depth investigations.

In order to identify accident cause and consequences, the investigation included a full reconstruction of the accident, including the documentation of human, environment and vehicle factors, and an identification of all accident contributing factors. Specific attention was paid to the conditions under which the accident took place, the initial conditions of the accident (e.g., vehicles, travel direction, roadway alignment, lighting, traffic controls, etc.), as well as to the pre-crash motions of all involved vehicles. Vehicles involved in the causation of the accident were defined as Other Vehicles (OV), whether or not they were struck. Intended motions (e.g., turning, negotiating a bend, etc.) as well as collision avoidance manoeuvres were investigated and coded. Detailed post-crash vehicle inspections provided investigators with information regarding the condition of the vehicle as well as evidence of contact damage, use of lights and marks on the tyre from braking. All of this information added to the accuracy and reliability of the in-depth accident reconstruction.

Accident scenes were documented in detail in order to identify any conditions which might have contributed to the cause of the accident. Braking skid marks, points of contact and physical damage were all precisely documented. The entire scene was recorded on a scaled diagram in order to record the pre-crash, crash and post-crash motions of the vehicles. The lines of sight, as seen by the PTW rider and the OV driver were documented photographically by physically walking along the pre-crash paths whenever possible. The presence of stationary view obstructions (e.g., road signs) or mobile view obstructions (e.g., lorries or buses), was documented using photographs and included in the detailed scene diagrams.

Concurrent with the on-scene vehicle and site investigations, investigators trained in human factors conducted interviews in order to obtain as much information as possible from those involved in or witnesses to the accident or its consequences. The type of licences held by the PTW rider and vehicle driver as well as their training and experience, were all coded to identify any potential trends or risk factors associated with vehicle drivers or PTW riders.

Immediately following the accident, the investigators initiated the procedures necessary to obtain detailed medical information for each rider or passenger that was injured during the accident. Whenever possible, a complete medical summary was obtained and each individual injury was coded using the Abbreviated Injury Scale (AIS) developed by the Association for the Advancement of Automotive Medicine (AAAM, 1998). Thus, each injury was assigned a unique 7 digit numerical injury identifier which included the AIS value or severity code which utilized the following convention:

<u>AIS Code</u>	<u>Description</u>
1	Minor
2	Moderate
3	Serious
4	Severe
5	Critical
6	Maximum

Accident reconstruction

Upon completion of the on-scene accident investigations, each research team completed a detailed reconstruction and accident causation worksheet describing all phases of the accident and all potential causes. Pre-crash motions of the PTW, PTW rider, passenger and all involved vehicles were determined and any collision avoidance manoeuvres were identified. Traditional accident reconstruction techniques were used to determine both pre-crash speeds and impact speeds of all vehicles.

In addition to the vehicle motions, a complete understanding of the kinematics of the PTW rider and passenger during all phases of the accident sequence was developed. The kinematic description included listing all surfaces that were contacted during the crash and post crash motion of the rider and passenger. Clothing effectiveness was then coded relative to the effect that the clothing had upon AIS 1 level injuries. It is generally accepted in the scientific literature that appropriate PTW rider clothing has a minimal effect upon reducing many serious PTW rider injuries (Noordzij et al., 2001). The decision to consider only AIS 1 injuries was based upon the need for a consistent coding methodology that provided practical procedures to get objective results.

The effect of the clothing could be coded under a number of categories. If the kinematic analysis indicated direct contact with surfaces that could cause AIS 1 injury (e.g., roadway) but the medical record review provided no such injuries, then the clothing was considered to have prevented AIS 1 injury. If there was AIS 1 injury, but the investigators felt that the clothing had reduced the magnitude and severity of the AIS 1 injuries, then the clothing was coded as having reduced the injury severity. If the clothing had no effect upon the AIS 1 injuries, then this code was applied for the case.

In addition to these possible codings, if the coverage was not present and injury occurred, this was coded. This includes situations where some type of clothing was worn, but the clothing did not cover the entire area (e.g., t-shirts, shorts, sandals, etc.). Similarly, if there was no contact in this region (based upon the kinematic analysis), then the code “no injury producing contact in region” was used.

The last portion of the investigative process was to determine the contribution of a given factor (e.g., human, vehicle or environmental factor) in the causation of the accident. Typically this was done at a team meeting, where all the investigative specialists were able to provide input on the accident’s causation. A precipitating event was identified for each case and was defined as the failure or manoeuvre that immediately led to the accident. This might or might not have been the primary accident contributing factor. All events were described relative to this precipitating event whenever possible. Based upon the in-depth accident investigation, all potential environmental, vehicle and human factors were evaluated. For each factor, a decision was made as to whether or not the factor:

- i) was present but was not a contributing factor; or,
- ii) was the precipitating event that initiated the accident sequence; or,
- iii) was the primary contributing factor in the accident causation; or,
- iv) was a contributing factor that was present in addition to other contributing factors; or,
- v) was not applicable, because it was not present.

Quality control

Development of consistent data coding and data analysis techniques between five research teams with different levels of accident investigation experience was essential for the success of the research project. Common training had been provided to each team and participation in the OECD “Inter-team Workshops” maintained a consistent and harmonized level of knowledge and understanding throughout the course of the data collection. These activities strengthened the consistency between each research team and maximized the overall quality of the data collected. Additional internal and external (i.e., OECD) quality control activities were also introduced throughout the data collection period to monitor and maintain the consistency between each research team. All quality control activities were conducted according to the recommendations and requirements of the OECD Common Methodology for on-scene in-depth motorcycle accident investigations (OECD, 2001).

Upon conclusion of the case analysis, the completed data questionnaire was entered into an electronic database and forwarded to a central data facility at the University of Pavia. For each case all raw data was properly sanitized of personal data and permanently archived by the research team. Typically, the archive included over 50 digital photographs of the scene, vehicles and rider clothing, a scene diagram indicating all vehicle motion, the interview forms, vehicle inspection forms and accident reconstruction calculations. This was done in order to preserve the valuable in-depth investigation materials for potential future research.

The results of this two year multi-country study are presented in this report. All of the project objectives have been met and it is expected that this report and the data associated with it will provide all stakeholders with a clear analysis of the causes and consequences of PTW accidents.

Explanation of legal categories and PTW styles

For those readers who are not familiar with PTW legal categories, PTW styles or the presentation of statistical data tables, this section has been provided as a guide to understanding the information contained in this MAIDS report.

PTW legal category

As part of the regulation for PTW operation in Europe, PTWs have been divided into several different vehicle categories based upon their engine capacity and design speed. There are currently two dominant PTW legal categories: the L1 and L3 vehicle categories. L1 vehicles include both mopeds and mofas while L3 vehicles include motorcycles. The definitions of these categories are as follows:

Moped *A two wheeled vehicle with an engine cylinder capacity in the case of a thermic engine not exceeding 50 cm³ and whatever the means of propulsion a maximum design speed not exceeding 50 km/h. A moped is an L1 vehicle and might be designed to have pedals, or not to have pedals.*

Mofa *A moped with a maximum design speed not exceeding 25 km/h. A mofa is an L1 vehicle and might be designed to have pedals, or not to have pedals.*

Motorcycle A two wheeled vehicle with an engine cylinder capacity in the case of a thermic engine exceeding 50 cm³ or whatever the means of propulsion a maximum design speed exceeding 50 km/h. A motorcycle is an L3 vehicle.

This report will use the term PTW to describe all powered two wheelers, the term L1 vehicle to describe mopeds and mofas and the term L3 vehicle to describe motorcycles.

PTW styles

Over the past 20 years, there has been a constant evolution of PTW. This has been done in response to the needs, interests and riding patterns of consumers. Today, many PTW styles are available in both the L1 and L3 vehicle categories.

The OECD Common Methodology for on-scene in-depth motorcycle accident investigations (OECD, 2001) defines a classification of PTW styles. The pictures below are provided as illustrations of the definitions in the OECD classification and are not the only example of a particular PTW style.



Figure 2.1: Conventional street style PTW



Figure 2.2: Sport style PTW



Figure 2.3: Cruiser style PTW



Figure 2.4: Chopper style PTW



Figure 2.5: Touring style PTW



Figure 2.6: Scooter style PTW



Figure 2.7: Step-through style PTW



Figure 2.8: Sport Touring style PTW



Figure 2.9: Enduro style PTW

Explanation of data presentation

The data has been presented as frequency distributions and cross-tabulations. In each cross-tabulation, there are four rows per major category. The first row presents the frequency of the given cell. The second row presents the row percentage for that category while the third row presents the column percentage for the column category. The fourth row provides the overall percentage of a particular cell relative to the table's total. Figure 2.10 shows how to read a sample cross-tabulation.

In order to allow the reader to quickly locate specific values discussed in the report, the corresponding values have been highlighted in both the text and the table.

Example of a cross-table

Frequency Row Percent Column Percent Total Percent		Collision contact code for max. rider injury on neck				Total
		OV	PTW	Road/roadside	Helmet	
Rider neck inju severity	Minor	7	0	9	3	19
		36.8%	0.0%	47.4%	15.8%	100.0%
		70.0%	0.0%	90.0%	75.0%	76.0%
		28.0%	0.0%	36.0%	12.0%	76.0%
	Moderate	1	1	1	1	4
		25.0%	25.0%	25.0%	25.0%	100.0%
		10.0%	100.0%	10.0%	25.0%	16.0%
4.0%		4.0%	4.0%	4.0%	16.0%	

Figure 2.10: Illustration of sample cross-tabulation and how to read a cross-tabulation (Row percentage = red, column percentage = green, total percentage = blue).

Statistical tests

To understand the relationship between the accident data and the exposure data, a chi-square statistical test was conducted to test the null hypothesis that there was no relationship between the accident and exposure variables. If the significance level (i.e., the p value for a two tailed test) of the computed chi-square statistic is below 0.05, then the two groups are considered to be significantly different and the null hypothesis was rejected. If the difference between the exposure population and the accident population is found to be significant (i.e., $p < 0.05$), then an odds ratio is computed for the variable. If the odds-ratio is found to be above 1.0, then the factor is considered to be over-represented in the accident data. Similarly, if the odds-ratio is found to be below 1.0, then the factor is considered to be under-represented in the accident data. A complete explanation of the chi-square test statistic is presented in Annex B.

3.0 General accident characteristics

A complete summary of all cases collected by each research team is presented in Table 3.1.

Table 3.1: Total number of cases collected

	Cases	Controls	Total
University of Pavia (Italy)	200	200	400
TNO (Netherlands)	200	200	400
REGES (Spain)	121	123	244
ARU-MUH (Germany)	250	250	500
CEESAR (France)	150	150	300
Total	921	923	1844

There were 103 accident cases (11.2%) within the MAIDS database that involved a fatality of either the rider or the passenger (Table 3.2). A fatality was defined as any death within 30 days of the accident. The number of fatal cases collected by the German research team was the result of their focus upon more seriously injured riders.

Table 3.2: Number of fatal cases

	Fatal	Not fatal	Total
University of Pavia (Italy)	11	189	200
TNO (Netherlands)	15	185	200
REGES (Spain)	12	109	121
ARU-MUH (Germany)	49	201	250
CEESAR (France)	16	134	150
Total	103	818	921

Note: There were multiple fatalities in two cases.

Table 3.3 gives the distribution of the PTW legal categories for both the accident data and the exposure or case control data. The data shows that the majority of vehicles were L3 vehicles; however, when compared to the exposure data, they were neither over- nor under-represented in the accident data. Therefore, there is no increased risk in the operation of an L3 vehicle when compared to other PTW legal categories. Similar findings can be reported for the mofa legal categories. A chi-square test of the relationship between the L1 accident data and the L1 exposure data shows that the L1 vehicles are over-represented in the MAIDS database ($p < .05$).

Table 3.3: PTW legal category

	Accident data		Exposure data	
	Frequency	Percent	Frequency	Percent
L1 vehicle - mofa	28	3.0	49	5.3
L1 vehicle - other	370	40.2	324	35.1
L3 vehicle	523	56.8	550	59.6
Total	921	100.0	923	100.0

Table 3.4 presents the PTW collision partners for all cases collected during this research project. Passenger cars were the most frequent collision partner (60.0%), followed by the roadway (9.0%). The high percentage of passenger car, truck, sport utility

vehicle (SUV) and bus collision partners is not unusual since most of the accidents took place in an urban environment where PTWs must share the roadway with other motorized vehicles. This distribution only represents the object with which the PTW ultimately collided, and does not suggest accident causation, since there were many cases in which the PTW rider successfully avoided colliding with a car, PTW, truck, etc., but instead impacted the roadway or some other fixed object. The PTW collision partner is not necessarily the OV. Single vehicle accidents (e.g., running off the roadway) are also included in this distribution.

Table 3.4: PTW collision partner

	Frequency	Percent
Passenger car	553	60.0
Another PTW	64	6.9
Truck/SUV/bus/	77	8.4
Bicycle/pedestrian	19	2.1
Fixed object	74	8.0
Roadway	83	9.0
Parked vehicle	25	2.7
Animal	3	0.3
Other	23	2.5
Total	921	100.0

Table 3.5 indicates that the majority of the accidents collected during this study involved a collision with an OV (80.2%). One hundred and forty-three of the cases (15.5%) involved only the PTW and PTW rider (e.g., a single vehicle accident).

Table 3.5: Number of OVs involved in the accident

	Frequency	Percent
None (single vehicle accident)	143	15.5
One	738	80.2
Two	36	3.9
Three	4	0.4
Total	921	100.0

Table 3.6 indicates that the majority of accidents involved only the PTW operator and that 8.6% of all cases involved a PTW passenger. There were no cases collected with more than one PTW passenger. Table 3.7 shows the number of fatal PTW accidents in which a passenger was present. Please note that the value presented in Table 3.7 does not represent the number of passengers who were killed, but rather the number of cases in which there was a fatality involved in the crash. There were only five cases in which the passenger was reported as the fatality.

Table 3.6: Number of passengers on PTW

	Frequency	Percent
None	842	91.4
One	79	8.6
Total	921	100.0

Table 3.7: Number of passengers on PTW (fatal accidents only)

	Frequency	Percent
None	90	87.4
One	13	12.6
Total	103	100.0

Table 3.8 indicates that in our sample approximately three-quarters of all accidents occurred within an urban area. Approximately three quarters of all collected accidents took place in an urban area. An urban area was defined as a built up area with a population of 5,000 or more inhabitants. Similarly, a community was defined as rural if its population density is less than 150 people per square kilometre (OECD, 2001).

When distributed according to PTW legal category, the data shows that more of the L1 vehicles were involved in accidents which took place in an urban area than L3 vehicles. The distribution of accidents is directly related to the demographic characteristics of the sampling area for each research team.

Table 3.8: Accident scene, type of area

	L1 vehicles		L3 vehicles		Total	
	Frequency	Percent of L1	Frequency	Percent of L3	Frequency	Percent
urban	342	85.9	324	62.0	666	72.3
rural	43	10.8	186	35.6	229	24.9
other	13	3.3	13	2.4	26	2.8
Total	398	100.0	523	100.0	921	100.0

The distribution of the PTW collision partners by type of area is presented in Figure 3.1. The data indicates that in an urban area, the most frequent collision partner is a passenger car. This finding was certainly expected, as was the finding that the majority of truck/SUV/bus collisions occur in an urban area because that is where most vehicles circulate.

In a rural area, PTW to passenger car collisions decrease (64.1% to 46.7%) while PTW to PTW collisions increase (6.3% to 9.6%). There is an increase in the number of collisions between a PTW and a fixed object (4.2% to 19.7%) as well as collisions with the roadway (7.7% to 12.2%). The data shown in Figure 3.1 may be found in Annex C, Table C.1.

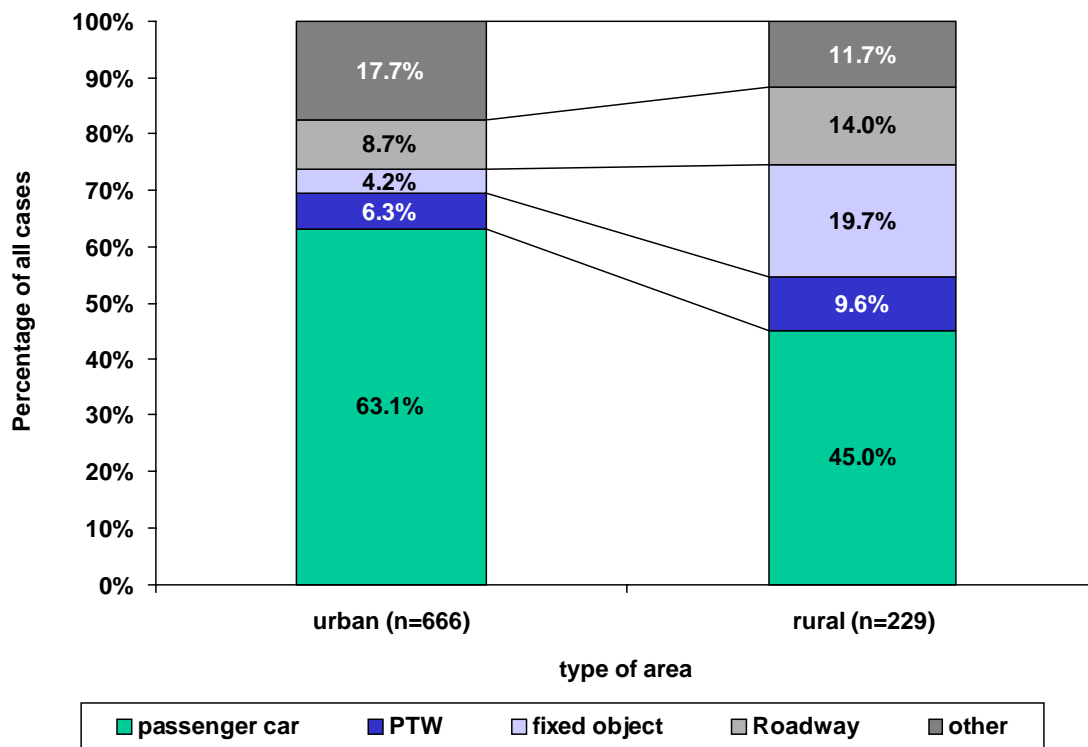

Figure 3.1: PTW collision partner by type of area

The MAIDS data indicates that half of all PTW accidents were found to take place at an intersection (Table 3.9). An intersection was defined as any on-grade crossing or intersection of two public roadways (OECD, 2001).

Table 3.9: Accident location

	Frequency	Percent
Intersection	500	54.3
Non-intersection	358	38.9
Other	63	6.8
Total	921	100.0

Figure 3.2 shows the time of day in which both the fatal and non-fatal accidents occurred. The data indicates that most accidents occurred between 17h01 and 18h00, with the most accidents taking place from 14h01 to 20h00. It is not possible to state whether a given time of day is “more dangerous” than any other time since PTW rider exposure data (i.e., number of riders on the roadway at all hours of the day) is not available. Most of the fatal accidents occurred between 12h01 and 22h00, with the most frequent number of cases taking place between 19h01 and 20h00. The data shown in Figure 3.2 may be found in Annex C, Table C.2.

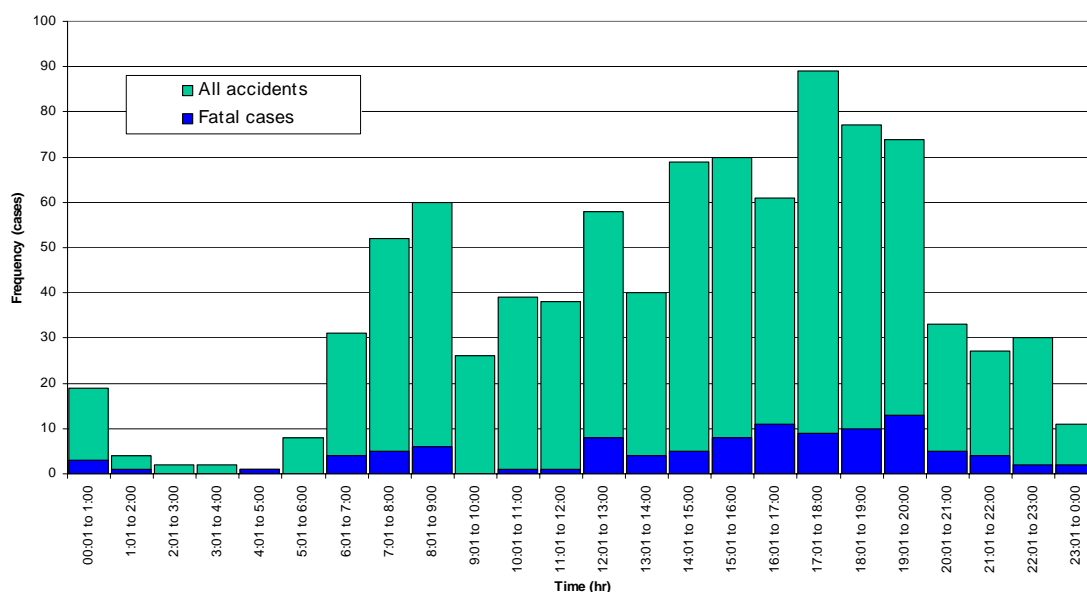

Figure 3.2: Time of day accident occurred

Table 3.10 shows that the most accidents took place on Tuesday (159 cases, 17.3%), followed closely by Monday (152 cases, 16.5%). Since the exposure data was not collected at accident-related times (i.e., they were collected during petrol station operating hours), it was not possible to determine if one day of the week was more dangerous for riding a PTW than any other day of the week.

Table 3.10: Day of week accident occurred

	Frequency	Percent
Monday	152	16.5
Tuesday	159	17.3
Wednesday	134	14.5
Thursday	140	15.2
Friday	139	15.1
Saturday	76	8.3
Sunday	121	13.1
Total	921	100.0

Figure 3.3 presents the month in which the accidents occurred. The data indicates that PTW accidents were more frequent during the spring and summer months, decreasing during the month of August. The frequency of accidents also decreases after the month of September, probably due to decreases in temperature and presence of adverse riding conditions in the northern parts of Europe.

Because the exposure data was not collected at accident-related times, it is not possible to determine if any given month is more dangerous than any other. Therefore, this data is presented for information on frequency only. The data shown in Figure 3.3 may be found in Annex C, Table C.3.

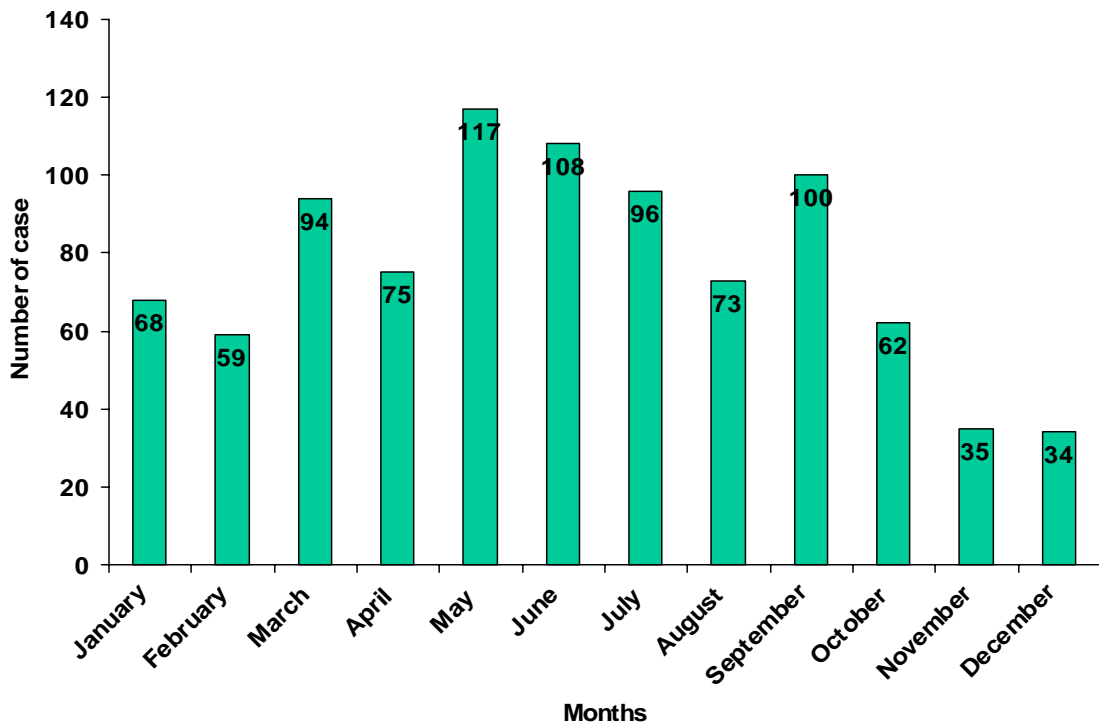

Figure 3.3: Month in which accident occurred

A general accident typology was determined for the 921 accidents. Since PTW accidents are complex events that often involve multiple collisions, the investigators often had to choose the accident typology that best fitted the accident being investigated. Investigators were asked to describe an accident using one of twenty-five specific accident typologies generated by the OECD Technical Experts Group (see the report “MAIDS Report on Methodology and Process”).

The data presented in Figure 3.4 indicates that there is a wide diversity of accident types. When the data is partitioned according to PTW legal category the data shows that more L3 vehicles are involved in collisions where the PTW and the OV are travelling in opposite directions, with the OV turning in front of the L3 vehicle (10.5% versus 6.0%). The data shown in Figure 3.4 may be found in Annex C, Table C.4.

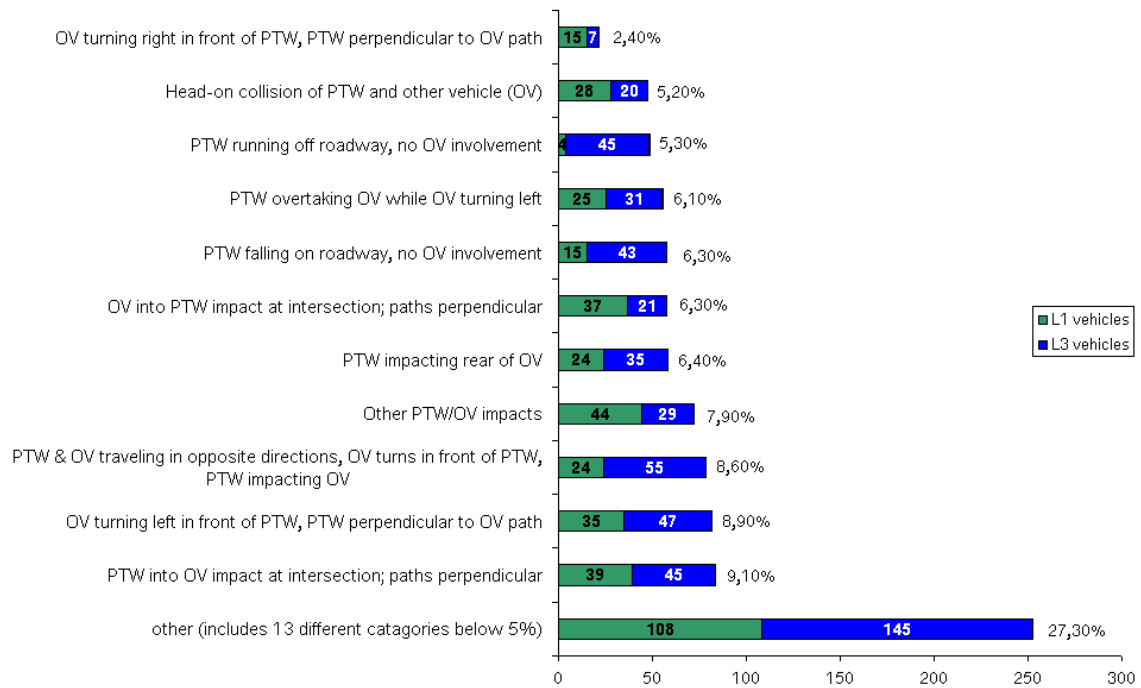

Figure 3.4: PTW accident configuration by legal category

Findings on general accident characteristics

- There were 103 cases involving a fatality of either the rider or the passenger.
- L1 vehicles were over-represented in the accident sample when compared with the exposure sample.
- More L1 vehicles were involved in accidents which took place in an urban area than L3 vehicles. (85.9% v. 62%).
- 54.3% of the PTW accidents took place at an intersection.
- Passenger cars were the most frequent collision partner (60%).
- 72% of the accidents took place in urban areas.
- A PTW was more likely to collide with a passenger car in an urban area than in a rural area. (64.1% v. 46.7%).
- Due to the absence of comparable exposure data, it was not possible to determine if any month, day of the week or time of day was a risk factor.

4.0 Accident causation

At the end of each case investigation, the team decided on the primary accident contributing factor of the accident. This was the human, vehicle or environmental factor which the research team considered to have made the greatest contribution to the overall outcome of the accident.

Table 4.1 provides a summary of the general categories of primary accident contributing factor. Human factors were coded as the primary accident contributing factor in approximately 87.5% of all cases (i.e., 37.1% + 50.4%, indicating that vehicle operators are largely responsible for accident causation. A more detailed description of these primary accident contributing cause factors appears in the next section of this report. PTWs as vehicles were identified as the primary cause factor in six cases (less than 1% of all cases). The environment was considered to be the primary accident contributing factor in 7.7% of all cases.

Table 4.1: Primary accident contributing factor

	Frequency	Percent
Human – PTW rider	341	37.1
Human – OV driver	464	50.4
Vehicle	6	0.7
Environmental	72	7.7
Other failure	37	4.1
Total	921	100.0

As noted above, the primary contributing factor for most PTW accidents is the human. To understand the specific human causal factors better, a set of human failure response codes was developed. If the primary accident cause factor was considered to be a human factor, each research team was instructed to apply the most appropriate failure coding for either the PTW rider or the OV driver. The failures were defined using the following definitions (OECD, 2001):

Perception failure: The investigator determines through reconstruction analysis or contributory factor analysis that the PTW rider or the OV driver failed to detect the dangerous condition based upon the strategy that he was using to detect dangerous conditions. For example; the OV driver fails to check his side view mirrors and moves into adjacent lane, striking the PTW that was in the adjacent lane.

Comprehension failure: The investigator determines through reconstruction analysis or contributory factor analysis that the PTW rider or OV driver perceived a dangerous situation; however, they failed to comprehend the danger associated with that situation. An example of a comprehension failure would be a rider who observes flashing police lights travelling towards him; but fails to comprehend that the police official is going to turn immediately in front of him.

Decision failure: The investigator determines through reconstruction analysis or contributory factor analysis that the PTW rider or the OV driver failed to make the correct decision to avoid the dangerous condition based upon his strategy. For example; the PTW rider observes yellow caution lights and continues on same path of travel at same speed

based on the PTW rider's decision to continue through the intersection. The PTW rider hits the side of a passenger car moving perpendicular to direction of the PTW.

Reaction failure: The investigator determines through reconstruction analysis or contributory factor analysis that the PTW rider or the OV driver had failed to react to the dangerous condition, resulting in a continuation or faulty collision avoidance. For example; the PTW rider observes small objects on the roadway and decides to continue on the same path of travel. An accumulation of these small objects in the tyre of the PTW causes the PTW rider to lose control of the PTW and crash.

The data presented in Figure 4.1 indicates that the most frequently reported primary accident contributing factor was a perception failure on the part of the OV driver. Since this reporting is for the OV driver, this data indicates that the primary contributing factor in 36.6% of all MAIDS cases was the inability of the OV driver to perceive the PTW or the PTW rider. The next most frequently coded primary accident contributing factor was a decision failure on the part of the PTW rider (13% of all cases). This corresponds to those cases where the PTW rider failed to make the correct decision to avoid a dangerous condition.

The next most frequently reported primary accident contributing factor was a perception failure on the part of the PTW rider (12% of all cases). These were reported cases in which the PTW rider did not perceive the dangerous situation and got involved in the crash as a result of this lack of perception. A detailed description of the data shown in Figure 4.1 may be found in Annex C, Table C.5.

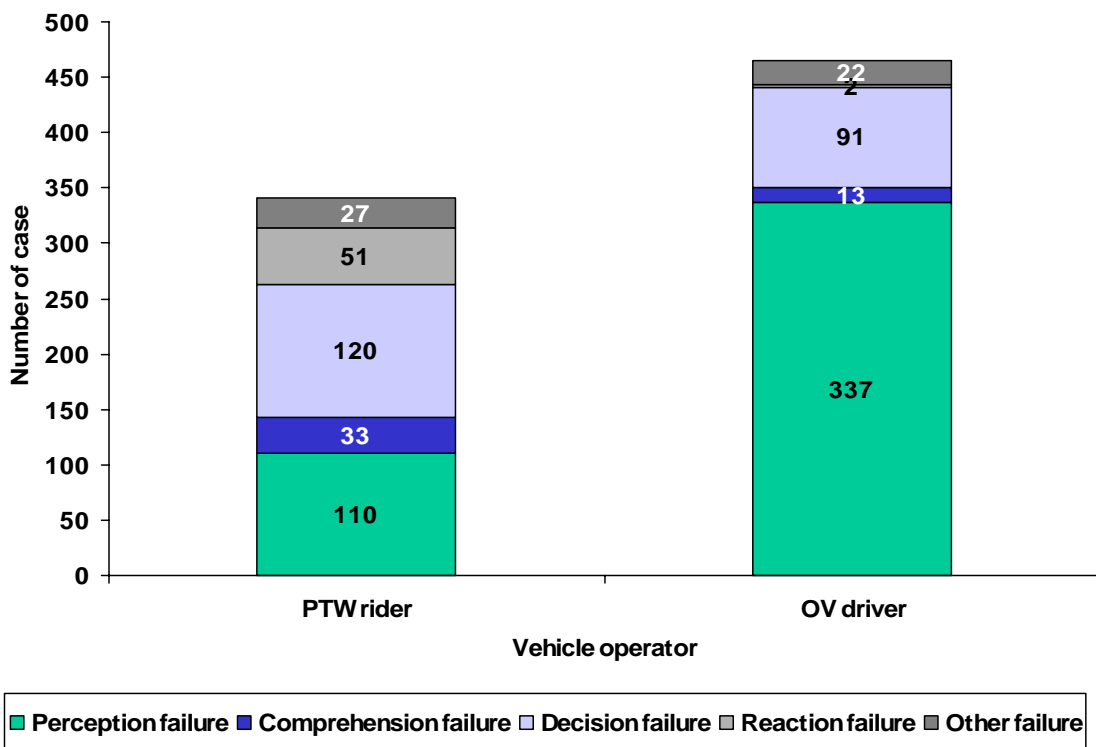

Figure 4.1: Detailed primary accident contributing factors
 (Note: 6 cases of PTW technical failure were reported, 72 cases of environmental cause factor were reported, and 37 cases of other human failure were reported)

In addition to the primary accident contributing factor, each research team identified up to four additional contributing factors for each accident. A contributing factor was defined as any human, vehicle or environmental factor which the investigator considers to have contributed to the overall outcome of the accident. Primary contributing factors were not recoded as contributing factors; therefore, the factors presented below represent contributing factors that were observed in addition to the primary contributing factor.

Table 4.2 indicates that the PTW rider was considered to be an additional contributing factor in 43.7% of all contributing factors. The OV driver was also indicated as an additional contributing factor in 28.6% of all contributing factors.

Table 4.2: Other accident contributing factors
(Note: Multiple responses could be made for each case)

	Frequency	Percent
PTW rider	900	43.7
OV driver	589	28.6
PTW technical failure	32	1.6
OV technical failure	10	0.5
Environmental cause	300	14.6
Other	87	4.2
Unknown contributing factor	141	6.8
Total	2059	100.0

Human contributing factors

The evaluation of the human factor related accident cause factors required a complete evaluation of the actions of the PTW rider and the OV driver during all phases of the accident sequence. While some subjective assessment was required, investigators were trained to integrate the results of the interviews into their analysis of the actions of the PTW rider and the OV driver (if applicable). This procedure reduced the subjectivity of the assessment and maximized the consistency in reporting between the different teams. Investigators were also asked to evaluate the more subjective human factors issues (i.e., traffic strategies), in relation to the typical driving behaviours in their sampling area.

Table 4.3 provides information regarding the number of cases in which an attention failure was considered to be a contributing factor to accident causation. An attention failure was defined as any activity of the vehicle operator that distracted him or her from the normal operations of the vehicle (PTW or OV), including the normal observation of traffic both in front of and behind the vehicle operator. An example of a distraction would be to turn attention from the roadway to focus upon something that is taking place at the side of the roadway or someone that is standing at the side of the roadway. This loss of concentration upon the riding or driving activity has the potential to reduce the reaction time of the vehicle operator and thus reduce the amount of time available for collision avoidance. It is obvious that a proper assessment of the presence of an attention failure depends upon the interview skills of the investigator, since in most cases, the rider or OV driver must admit to being distracted from normal vehicle operations.

The data presented indicates that PTW rider attention failure contributed to the accident in 10.6% of all MAIDS cases (n=98). There were 29 cases in which it was

unknown whether or not an attention failure contributed to accident causation. These cases were most likely fatal cases where it was not possible to interview the PTW rider.

Table 4.3: Attention failure, including distractions and stress (PTW rider)

	Frequency	Percent
Attention failure was present, but did not contribute to accident causation	35	3.9
Attention failure was present and contributed to accident causation	98	10.6
No attention failure	759	82.4
Unknown if attention failure was present	29	3.1
Total	921	100.0

Table 4.4 indicates that more OV drivers experienced attention failure because it was reported as a contributing factor in 18.4% of all cases involving an OV.

Table 4.4: Attention failure, including distractions and stress (OV driver)

	Frequency	Percent
Attention failure was present, but did not contribute to accident causation	31	4.0
Attention failure was present and contributed to accident causation	143	18.4
No OV, or no attention failure	552	71.0
Unknown if attention failure was present	52	6.6
Total	778	100.0

Table 4.5 reports on the number of cases in which a PTW rider traffic-scan error contributed to the causation of the accident. A traffic-scan error was considered to be any situation in which the rider did not observe or perceive oncoming traffic or traffic that may have been entering the roadway from some other direction. PTW riders were not expected to see through parked vehicles or around buildings; therefore, only normal traffic-scanning was used as the reference for the determination of a traffic-scanning error. The data indicates that a PTW rider traffic-scan error was reported in 27.7% of all cases involving an OV.

Table 4.5: Traffic-scan error (PTW rider)

	Frequency	Percent
Traffic-scan made no contribution to accident causation	478	51.9
Traffic-scan error was present and contributed to accident causation	255	27.7
Not applicable or no other traffic present	176	19.1
Unknown	12	1.3
Total	921	100.0

When compared to PTW riders, OV drivers were reported to have a much higher frequency of traffic-scan related errors. Table 4.6 indicates that a traffic-scanning error related to accident causation was reported in 62.9% of cases involving an OV.

Table 4.6: Traffic-scan error (OV driver)

	Frequency	Percent
Traffic-scan made no contribution to accident causation	205	26.3
Traffic-scan error was present and contributed to accident causation	489	62.9
Not applicable, no OV or no other traffic present	69	8.9
Unknown	15	1.9
Total	778	100.0

For each case, the presence of visual obstructions was considered along the pre-crash path of both the PTW and the OV. Confirmation of the visual obstruction was done by the on-scene photography along the pre-crash path of each vehicle. In some cases, the visual obstruction was mobile (i.e., a moving truck), the investigator made every effort to confirm its presence by corroboration with more than one accident witness.

Table 4.7 reports that approximately 26.4% of cases included some type of visual obstruction for the PTW rider (i.e., 7.9% + 18.5%). The neglect of the visual obstruction contributed to accident causation in 18.5% of cases. Table 4.8 reports a similar percentage of cases which included a visual obstruction (i.e., 29.7%, 7.1% + 22.6%) and a similar but higher percentage of cases in which the OV driver had neglected the visual obstruction and this neglect contributed to the accident (i.e., 22.6%).

Table 4.7: Visual obstructions neglected (PTW rider)

	Frequency	Percent
Visual obstructions were present but did not contribute to accident	73	7.9
Visual obstructions present and contributed to accident	170	18.5
Not applicable, no visual obstructions	674	73.2
Unknown if visual obstruction was neglected by PTW rider	4	0.4
Total	921	100.0

Table 4.8: Visual obstructions neglected (OV driver)

	Frequency	Percent
Visual obstructions were present but did not contribute to accident	55	7.1
Visual obstructions present and contributed to accident	176	22.6
Not applicable, no visual obstructions	529	68.0
Unknown if visual obstruction was neglected by OV driver	18	2.3
Total	778	100.0

Based upon the accident reconstruction, investigators were able to determine if a hazard was present and if that hazard had been detected prior to the collision. Temporary traffic hazards were included in the evaluation and were defined as a danger or risk present on a carriage way, excluding a roadway design or maintenance defect (OECD, 2001). Table 4.9 indicates that a total of 74 cases were identified where there was a temporary hazard detection situation involved in the collision. In 65% of these cases (i.e., 48 of the 74 cases), the PTW rider failed to detect the hazard and this failure contributed to the accident causation.

Table 4.9: Temporary traffic hazard detection failure (PTW rider)

	Frequency	Percent
Temporary traffic hazard present, but did not contribute to accident causation	26	2.8
Temporary traffic hazard present and contributed to accident causation	48	5.2
Not applicable, no temporary traffic hazard present	844	91.7
Unknown contribution	3	0.3
Total	921	100.0

Table 4.10 reports on the number of cases in which there was a temporary traffic hazard detection failure on the part of the OV driver. Of the 54 cases involving a temporary traffic hazard, the OV driver was considered to have failed to detect the hazard, thus contributing to the accident, in 67% of those cases (i.e., 36 of 54 cases). There were 12 cases reported in which it was unknown whether or not a temporary traffic hazard had contributed to the accident.

Table 4.10: Temporary traffic hazard detection failure (OV driver)

	Frequency	Percent
Temporary traffic hazard present, but did not contribute to accident causation	18	2.3
Temporary traffic hazard present and contributed to accident causation	36	4.6
Not applicable, no temporary traffic hazard present	712	91.5
Unknown contribution	12	1.6
Total	778	100.0

Table 4.11 shows the number of cases in which a faulty traffic strategy was found present and the number of cases in which the faulty traffic strategy contributed to the accident causation. A faulty traffic strategy was considered to be present whenever the PTW rider or the OV driver made a poor decision to perform a manoeuvre or movement. The assessment of the decision was made by investigators who were experienced PTW riders or OV drivers and based upon the general driving situations in the sampling area. Examples of faulty traffic strategies are a failure to provide turning signals or following a vehicle too closely, resulting in a rear-end collision.

The data in Table 4.11 indicates that there were 596 cases in which the PTW rider was considered to have had some type of faulty traffic strategy (i.e., 299 + 297 cases). The faulty traffic strategy was considered to have contributed to accident causation in approximately half of the reported cases where a traffic strategy was required.

Table 4.11: Faulty traffic strategy (PTW rider)

	Frequency	Percent
Traffic strategy made no contribution to accident causation	299	32.5
Traffic strategy contributed to accident causation	297	32.2
Not applicable, no other traffic present	322	35.0
Unknown if faulty traffic strategy was present	3	0.3
Total	921	100.0

OV drivers were involved in approximately the same percentage of cases with a faulty traffic strategy when compared to the PTW riders. Table 4.12 indicates that in 40.6% of the cases collected, the OV driver's faulty traffic strategy contributed to the accident causation.

Table 4.12: Faulty traffic strategy (OV driver)

	Frequency	Percent
Traffic strategy made no contribution to accident causation	218	28.1
Traffic strategy contributed to accident causation	316	40.6
Not applicable, or no other traffic present	229	29.4
Unknown if faulty traffic strategy was present	15	1.9
Total	778	100.0

Table 4.13 provides the information regarding the distribution of PTW speed relative to the surrounding traffic. This was based upon the accident reconstruction and interviews of any witnesses to the accident. In 73.8% of the cases, the PTW was considered to be travelling at a normal speed relative to the surrounding traffic or travelling in a condition without any other traffic. In 18.0% of cases (n=166), the PTW rider was travelling at a speed which was either above or below the surrounding traffic and this speed difference was considered to be a contributing factor. In 74 other cases (8.1%), the PTW was travelling at an unusual speed (i.e., higher or lower than surrounding traffic), yet this speed difference made no contribution to accident causation.

Table 4.13: Speed compared to surrounding traffic (PTW)

	L1 vehicles		L3 vehicles		Total	
	Frequency	Percent of L1	Frequency	Percent of L3	Frequency	Percent
Speed unusual but no contribution	35	8.8	39	7.5	74	8.1
Speed difference contributed to accident	57	14.3	109	20.8	166	18.0
No unusual speed or no other traffic (not applicable)	305	76.6	375	71.7	680	73.8
Unknown	1	0.3	0	0.0	1	0.1
Total	398	100.0	523	100.0	921	100.0

Table 4.14 indicates the number of cases in which the OV was found to travelling at a speed that was either higher or lower than the surrounding traffic. The data indicates that there were 98 cases in which a speed difference was observed between the OVs and the surrounding traffic. In 37 cases (4.8% of all cases with an OV); the speed difference did contribute to the accident, but in 61 cases, this speed difference made no contribution.

Table 4.14: Speed compared to surrounding traffic (OV)

	Frequency	Percent
Speed unusual but no contribution	61	7.8
Speed difference contributed to accident	37	4.8
No unusual speed or no other traffic (not applicable)	666	85.6
Unknown	14	1.8
Total	778	100.0

Environmental contributing factors

Table 4.15 indicates the distribution of a roadway design defect as a contributing factor for the PTW. A roadway design defect was considered to be a condition which presented a danger to PTW riders based solely upon the design of the roadway. Some examples include: failure to install signs to tell the PTW rider what to expect ahead, failure to install reflectors on adjacent roadway structures (e.g., bridge barriers), a curve with decreasing radius of curvature, any roadway with built-in view obstructions, an improper angle for railway tracks relative to roadway, or an inadequate distance to merge lanes. The lack of traffic controls at a given intersection was not considered to be a roadway design defect.

During the accident reconstruction, any analysis regarding the presence of a roadway design defect was done while considering how the roadway was intended for use and how the roadway was currently used. Unique features of the accident (example: high speed) were not to be taken into account when conducting this analysis and all roadway design defects were considered relative to the pre-crash path of the PTW.

The data indicates that roadway design defects were present in 57 cases, but did not contribute to the causation of the accident in 47% of those cases (i.e., 27 of the 57 cases). In 4 cases, the design defect was the precipitating event of the accident and in 7 cases the design defect was the primary contributing factor for accident causation. In the 19 remaining cases, the roadway design defect was a contributing factor to the accident.

Table 4.15: Roadway design defect (PTW)

	Frequency	Percent
Roadway design defect present but not a contributing factor	27	2.9
Roadway design defect was the precipitating event	4	0.4
Roadway design defect was the primary contributing factor	7	0.8
Roadway design defect was a contributing factor	19	2.1
Not applicable, no OV, or no roadway design defect present	864	93.8
Total	921	100.0

Table 4.16 provides information regarding the contribution of roadway design defects along the OV pre-crash path. The number of reported cases that involved a roadway design defect along the OV pre-crash path was found to be 62, higher than the number reported along the PTW pre-crash path. The roadway design defect was found to contribute to the accident in 42% of all reported cases involving a roadway design defect (i.e., 26 of the 62 cases reporting a roadway design defect). The defect was considered to be the precipitating event in 8 cases and was the primary contributing factor in another 6 cases (10% of all reported cases involving a roadway design defect). There were ten cases in which it was unknown if there was a roadway design defect along the pre-crash path of the OV.

Table 4.16: Roadway design defect (OV)

	Frequency	Percent
Roadway design defect present but not a contributing factor	22	2.8
Roadway design defect was the precipitating event	8	1.0
Roadway design defect was the primary contributing factor	6	0.8
Roadway design defect was a contributing factor	26	3.4
Not applicable, or no roadway design defect present	706	90.7
Unknown	10	1.3
Total	778	100.0

Table 4.17 describes the presence and influence of roadway maintenance defects as a contributing factor in accident causation for the PTW and PTW rider. A roadway maintenance defect was considered to be any roadway condition that was in poor repair or in need of repair. Examples of roadway maintenance defects would include potholes, loose bitumen and poor roadway kerb structures. These maintenance defects were treated and considered separately from those defects that would appear as a result of a roadway hazard (e.g., something on the roadway) or debris due to construction activities (e.g., sand).

The data shows that there were 146 reported cases of roadway maintenance defects. A maintenance defect was the precipitating event in 8 of those cases and was the primary contributing factor or a contributing factor in 25 cases (17.1% of cases involving a roadway maintenance defect). A roadway maintenance defect was reported as being present in 113 cases (12.3%), but was not found to be a contributing factor in those cases.

Table 4.17: Roadway maintenance defect (PTW)

	Frequency	Percent
Roadway maintenance defect present but not a contributing factor	113	12.3
Roadway maintenance defect was the precipitating event	8	0.9
Roadway maintenance defect was a contributing factor	6	0.6
Roadway maintenance defect was the primary contributing factor	19	2.1
Not applicable, no OV, or no roadway maintenance defect	774	84.0
Unknown	1	0.1
Total	921	100.0

There were 106 cases in which a roadway maintenance defect was reported for the OV (see Table 4.18). The data indicates that a maintenance defect was present but was not a contributing factor in 89.6% of those 106 cases. There was only one case in which a maintenance defect was the precipitating event and ten cases in which it was the primary contributing factor. The number of cases in which the roadway maintenance defect noted for the OV contributed to the accident was found to be much less than the number of cases in which the roadway maintenance defect noted for the PTW contributed to the accident (11 cases for the OV versus 33 cases for PTW).

Table 4.18: Roadway maintenance defect (OV)

	Frequency	Percent
Roadway maintenance defect present but not a contributing factor	95	12.2
Roadway maintenance defect was the precipitating event	1	0.1
Roadway maintenance defect was the primary contributing, factor	10	1.3
Not applicable, or no roadway maintenance defect	663	85.2
Unknown	9	1.2
Total	778	100.0

Table 4.19 shows the distribution of cases which report the presence of a traffic hazard as a contributing factor for the PTW rider. A traffic hazard was considered to be a temporary roadway obstruction or any object or material that was in the roadway as a result of construction or roadway maintenance operations.

A total of 56 cases were reported to involve a traffic hazard. In 60% of those reported cases, the traffic hazard contributed to the accident in some way, either as the precipitating event (10 cases, 17.9% of reported cases involving a traffic hazard), as primary contributing factor (6 cases, 10.7% of reported cases involving a traffic hazard) or a contributing factor (18 cases, 32.1% of reported cases involving a traffic hazard).

Table 4.19: Traffic hazard, including construction and maintenance operations (PTW)

	Frequency	Percent
Temporary obstruction present but not a contributing factor	22	2.4
Temporary obstruction was the precipitating event	10	1.1
Temporary obstruction was the primary contributing factor	6	0.7
Temporary obstruction was a contributing factor	18	2.0
Not applicable, no OV, or no temporary traffic obstruction	864	93.7
Unknown	1	0.1
Total	921	100.0

The distribution of traffic hazards along the OV pre-crash pathway is presented in Table 4.20. Forty-six traffic hazards were reported along the OV pre-crash path and 52.2% of these reported traffic hazards did not contribute to the causation of the accident. A traffic hazard did contribute to the accident in 13 cases (28.3% of reported cases involving a traffic hazard) and was considered the precipitating event in 3 cases (6.5% of reported cases of cases involving a traffic hazard). There were also 6 cases in which the traffic hazard was considered to be the primary contributing factor to the causation of the accident.

Table 4.20: Traffic hazard, including construction and maintenance operations (OV)

	Frequency	Percent
Temporary obstruction present but not a contributing factor	24	3.0
Temporary obstruction was the precipitating event	3	0.4
Temporary obstruction was the primary contributing factor	6	0.8
Temporary obstruction was a contributing factor	13	1.7
Not applicable, or no temporary traffic obstruction	722	92.8
Unknown	10	1.3
Total	778	100.0

There were 14 cases in which the MAIDS investigators made the determination that there was a traffic control defect or malfunction along the PTW rider's pre-crash path (see Table 4.21). A total of 29 cases included a traffic control defect or malfunction along the PTW pre-crash path. In 5 cases, the traffic control defect or malfunction was the primary contributing factor and in one case it was the precipitating event. There were an additional 8 cases where the traffic control defect or malfunction was a contributing factor in the causation of the accident (27.6% of reported cases involving a traffic control defect).

Table 4.21: Traffic controls defect or malfunction (PTW)

	Frequency	Percent
Traffic control defect or malfunction present but not a contributing factor	15	1.6
Traffic control defect or malfunction was the precipitating event	1	0.1
Traffic control defect or malfunction was the primary contributing factor	5	0.5
Traffic control defect or malfunction was a contributing factor	8	0.9
Not applicable, no OV, or no traffic control defection or malfunction	891	96.8
Unknown	1	0.1
Total	921	100.0

Table 4.22 presents the distribution of the reported traffic control defects or malfunctions along the OV pre-crash path and the effect of those defects or malfunctions upon accident causation. A total of 22 cases were reported to have included a traffic control defect or malfunction along the OV pre-crash path. In ten of these cases, the control defect or malfunction was a contributing factor and in another 2 cases, the traffic control defect was reported as the primary contributing factor. There were no reported cases in which the traffic control defect or malfunction along the OV pre-crash was the precipitating event.

Table 4.22: Traffic controls defect or malfunction (OV)

	Frequency	Percent
Traffic control defect or malfunction present but not a contributing factor	10	1.3
Traffic control defect or malfunction was the primary contributing factor	2	0.3
Traffic control defect or malfunction was a contributing factor	10	1.3
Not applicable, or no traffic control defect or malfunction	747	96.0
Unknown	9	1.1
Total	778	100.0

Table 4.23 shows the effect of weather as a contributing factor for the PTW rider in accidents collected during the MAIDS research project. The data presented indicates that weather made no contribution to accident causation in 92.7% of MAIDS cases (854 cases) and was the precipitating event in 7 cases (0.8% of all cases). The presence of severe rain or the presence of snow or ice causing loss of control at the time of the accident would be examples of weather acting as a precipitating event in a crash. If the weather condition affected the driving or visibility conditions (e.g., severe rain limited visibility), causing a collision due to the lack of visibility, then the weather would be considered to be a primary contributing factor. There were 18 cases in which the weather was reported as being a primary contributing factor for the PTW (2.0% of all cases). The weather was also reported to contribute to accident causation in 42 cases (4.6% of all cases).

Table 4.23: Weather-related problem (PTW)

	Frequency	Percent
Weather made no contribution to accident	854	92.6
Weather related problem was the precipitating event	7	0.8
Weather related problem was the primary contributing factor	18	2.0
Weather related problem was a contributing factor	42	4.6
Total	921	100.0

There were 26 reported cases in which weather-related problems contributed to the accident causation with respect to the OV (see Table 4.24). In two cases, the weather-related problem was coded as being the precipitating event and in four other cases, it was coded as the primary contributing factor to accident causation. In the remaining twenty cases, the weather was a contributing factor in the causation of the accident. There were ten cases in which the role that weather played in accident causation relative to the OV was unknown.

Table 4.24: Weather-related problem (OV)

	Frequency	Percent
Weather made no contribution to accident	742	95.3
Weather related problem was the precipitating event	2	0.3
Weather related problem was the primary contributing factor	4	0.5
Weather related problem was a contributing factor	20	2.6
Unknown	10	1.3
Total	778	100.0

Vehicle contributing factors

Table 4.25 shows the frequency of accident-related PTW vehicle failures. A PTW vehicle failure was reported for any case where a PTW component failed or didn't function correctly and this component failure or lack of function contributed to the accident. A total of 47 cases were reported in which this occurred. There were an additional 8 cases reported in which the investigators were unable to determine if a PTW failure had occurred.

Table 4.25: PTW vehicle failure, accident cause related problem

	Frequency	Percent
Yes	47	5.1
No	866	94.0
Unknown	8	0.9
Total	921	100.0

Table 4.26 presents a detailed description of the PTW vehicle failures identified in Table 4.25. Seventy two percent of all PTW failures were related to the tyre or wheel and most often this was reported as a tyre blowout or a tyre failure. There were eleven reported cases of brake problems (1.2% of all cases).

Table 4.26: Specific cause of PTW vehicle failure, accident cause related problem

	Frequency	Percent
Tyre or wheel problem	34	3.7
Brake problem	11	1.2
Steering problem	1	0.1
Suspension problem	1	0.1
Not applicable, no PTW vehicle failure	866	94.0
Unknown	8	0.9
Total	921	100.0

Table 4.27 indicates that in 68.6% of all accidents, there was no fuel leakage noted at any time during the crash sequence. Investigators were asked to record fuel leakage at any time during the collision sequence, including the post-crash sequence where the PTW could potentially be on its side. Some minor leakage (i.e., less than 50 ml) was noted in 23.5% of all reported cases and considerable leakage (i.e., more than 50 ml) was reported in 6.5% of all cases.

Table 4.27: Fuel leakage

	Frequency	Percent
None	632	68.6
Minor leakage	216	23.5
Considerable leakage	60	6.5
Unknown if fuel leakage was present	13	1.4
Total	921	100.0

During the collision sequence as well as during the post-crash collision sequence, the PTW was often determined to be sliding on the roadway, which presents a significant risk of fuel ignition due to metal to pavement contact. Table 4.28 indicates that fires were noted in 10 reported cases or 1.1% of all accidents. Six of the reported fires occurred during the crash while the remaining 4 cases were determined to be post-crash fires, i.e., they occurred after the primary impact to a PTW that had already sustained some type of impact damage. It is important to note the fact that while there were 276 reported cases of fuel leakage (i.e., 216 + 60), there were only 10 reported fires.

Table 4.28: Fire occurrence

	Frequency	Percent
No	911	98.9
Yes	10	1.1
Total	921	100.0

Table 4.29 shows that there were four cases of OV failures were reported within the MAIDS database. The data presented in Table 4.31 indicates that these failures were related to either the tyre, wheel, brakes or electrical system.

Table 4.29: Specific cause of OV failure, accident cause related problem

	Frequency	Percent
Tyre or wheel problem	1	0.1
Brake problem	2	0.3
Electrical problem	1	0.1
Not applicable, no failure or no OV	749	96.3
Unknown	25	3.2
Total	778	100.0

Findings on accident causation

- The main primary contributing factors were the PTW rider (37.1%) and the OV driver (50.4%).
- In 10.6% of all cases, PTW rider inattention was present and contributed to accident causation.
- In 36.6% of all cases, the primary contributing factor was a perception failure on the part of the OV driver.
- 27.7% of PTW riders and 62.9% of OV drivers made a traffic-scan error which contributed to the accident.
- 32.2% of PTW riders and 40.6% of OV drivers engaged in faulty traffic strategies which contributed to the accident.
- A difference in speed compared to the surrounding traffic was identified as a contributing factor for PTWs in 18.0% of all cases and a contributing factor for the OV in 4.8% of all cases.
- The weather was a contributing factor or precipitating event for the PTW in 7.4% of cases.
- 3.7% of cases involved a PTW tyre problem and 1.2% a brake problem.

5.0 Vehicles

Vehicle characteristics

This section describes the factors related to the vehicles that were involved in the accident. Upon notification of an accident, each investigating team was required to inspect the accident vehicle within 24 hours of the crash. This confirmed the PTW manufacturer, model and style for each vehicle recorded in the database. The inspection procedure also allowed each team to obtain detailed vehicle information regarding the condition of the vehicle at the time of the accident. Inspection procedures included a visual inspection of all components as well as a mechanical inspection of the braking system, the engine/drive train components and the steering system. The inspections were conducted by investigators who were experienced in PTW maintenance issues; therefore, they were often able to provide a subjective assessment of the vehicle's pre-crash condition (e.g., condition of the braking system) and the effect that a given system might have had on the accident outcome.

Figure 5.1 presents the PTW styles involved in the 921 MAIDS accidents. Scooters were the most frequently reported PTW style, representing 38.4% of the cases collected within the five sampling areas. The next most frequent PTW style was a conventional street PTW (14.2% of all reported PTW styles). The presence of unknown PTW styles was due to the fact that the PTW was not available for inspection, or had been damaged beyond recognition. Note that the distribution of PTW styles is perhaps more typical of the sampling areas than the whole (enlarged) European Union.

Figure 5.1 indicates the distribution of the different PTW styles within the accident data and within the exposure data. The data indicates that 51 step-through PTWs were reported in the accident data (5.5%) while 70 step-through PTWs were observed in the exposure data. Statistical analysis revealed no significant difference between the accident data and the exposure data. The data also indicates that 14.2% of all accident PTWs were conventional street style PTWs, but only 12.7% of the exposure population. A chi-square statistical test showed that this PTW style was neither over- nor under-represented in the accident data. However, the chi-square test comparing modified conventional street PTWs in the accident data and exposure data was found to be significant (chi-square = 7.9, $p < 0.005$). This may be interpreted that within these sampling areas there is a greater risk of being involved in an accident while operating a modified conventional street PTW² as opposed to any other PTW style. The other PTW styles appear to be neither over nor under-represented in the MAIDS accident data when compared to the exposure data (i.e., they were not found to be significantly different). The data shown in Figure 5.1 may be found in Annex C, Table C.6.

² A modified conventional street PTW was defined as any conventional street PTW which had been modified with aftermarket components (e.g., exhaust system, etc.).

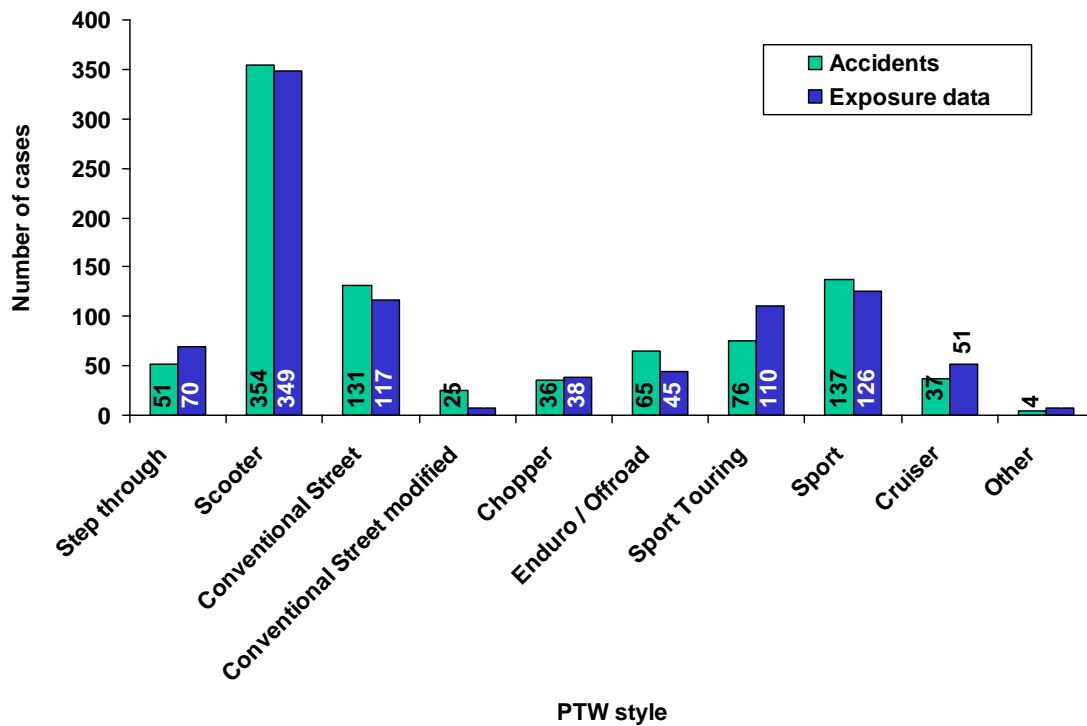

Figure 5.1: PTW style
 [Note: 5 accident cases and 1 exposure data case are unknown]

When the data is analysed according to PTW legal category, it shows that most L1 vehicles are scooter style (73.0%). The most frequently reported L3 vehicle styles was the sport style (24.1%) and conventional street style (19.9%). The data shown in Figure 5.2 may be found in Annex C, Table C.7.

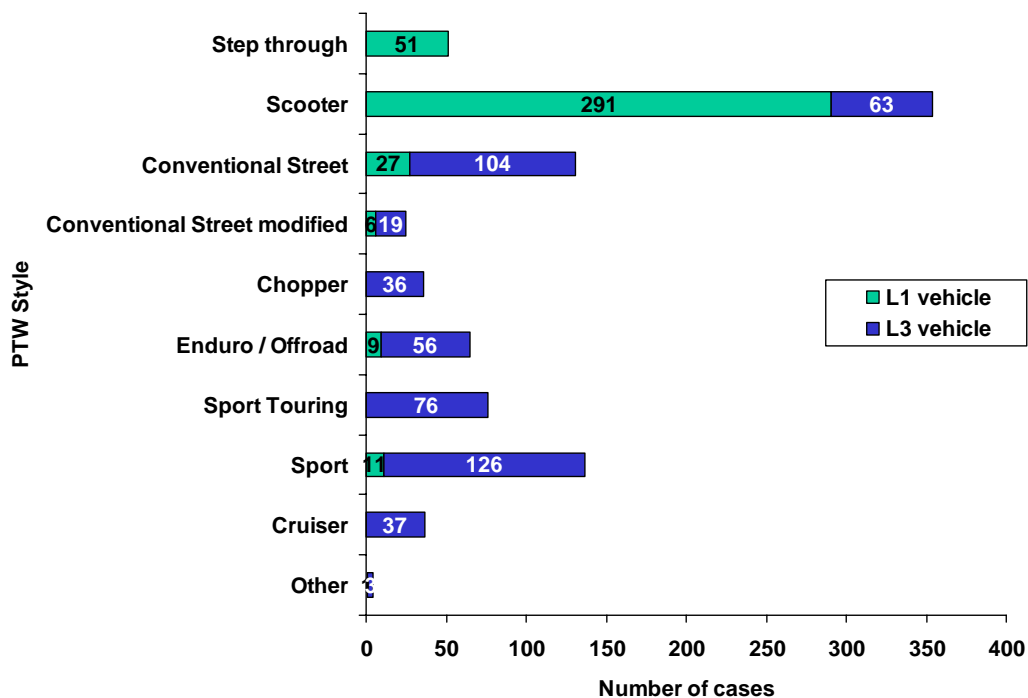

Figure 5.2: PTW style by legal category
 (Note: 5 cases unknown)

Table 5.1 presents the gross PTW mass distribution for the 921 MAIDS cases. PTW gross vehicle mass was taken from the vehicle specification sheet published by the manufacturer. The data indicates that PTWs with a gross vehicle mass under 100 kg accounted for 42.7% of the accident population, but 38.5% of the exposure data population. However, a chi-square test found no significant difference between the accident data and the exposure data for PTWs weighing below 100 kg, indicating that lighter PTWs are neither over nor under-represented in the accident data. Larger PTWs with a gross mass of between 201 and 250 kg were reported in 153 accident cases (16.6%) and 195 exposure cases (21.1%). A chi-square test found no significant difference between the accident data and the exposure data for PTWs weighing under 100 kg, indicating that lighter PTWs are neither over nor under-represented in the accident data.

Table 5.1: PTW gross mass

	Accident data		Exposure data	
	Frequency	Percent	Frequency	Percent
under 100	393	42.7	355	38.5
101 – 150	97	10.5	85	9.2
151 – 200	193	20.9	183	19.8
201 – 250	153	16.6	195	21.1
over 250	43	4.7	49	5.3
Unknown	42	4.6	56	6.1
Total	921	100.0	923	100.0

When the gross mass is analysed according to vehicle type, most L1 vehicles were reported to have a gross mass of less than 100 kg (91.4%). The gross mass of the L3 vehicles was more widely distributed with the 66.2% of all L3 vehicles reporting a gross mass being between 151 and 250 kg (i.e., 36.9% + 29.3%). 5.5% of L3 vehicles had a gross mass below 100 kg.

Table 5.2: PTW gross mass by PTW legal category

	L1 vehicles		L3 vehicles		Total	
	Frequency	Percent of L1	Frequency	Percent of L3	Frequency	Percent
Under 100	364	91.4	29	5.5	393	42.7
101 - 150	7	1.8	90	17.2	97	10.5
151 - 200	0	0.0	193	36.9	193	20.9
201 - 250	0	0.0	153	29.3	153	16.6
Over 250	0	0.0	43	8.2	43	4.7
Unknown	27	6.8	15	2.9	42	4.6
Total	398	100.0	523	100.0	921	100.0

Table 5.3 shows the distribution of engine displacement for the 921 cases. The highest frequency category reported was under 50 cc (42.7% of all cases), followed by bigger PTWs in the 501 to 750 cc category (22.4% of all cases). The large number of under 50cc vehicles was related to the high percentage of L1 vehicles in the MAIDS database. The data indicates that PTWs with engine displacement up to 50 cc accounted for 42% of the accident data and 40% of the exposure data. There was no significant difference between the accident data and the exposure data except for the over 1001 cc

category which was found to be under-represented (i.e. had less risk), (chi-square = 6.2, $p < .013$).

Table 5.3: Engine displacement

	Accident data		Exposure data	
	Frequency	Percent	Frequency	Percent
up to 50 cc	394	42.7	367	39.8
51 to 125 cc	89	9.7	86	9.3
126 to 250 cc	37	4.0	32	3.5
251 to 500 cc	56	6.1	50	5.4
501 to 750 cc	206	22.4	193	20.9
751 to 1000 cc	80	8.7	107	11.6
1001 or more	58	6.3	88	9.5
Unknown	1	0.1	0.0	0.0
Total	921	100.0	923	100.0

Table 5.4 shows the distribution of engine displacement by PTW category. As expected, the majority of L1 vehicles reported an engine displacement of 50cc or less (i.e., 99.0%). The four cases of an L1 vehicle with engine displacement greater than 51 cc (i.e., between 51 cc and 125 cc) represent L1 vehicles which have been tampered with in order to increase engine displacement.

The data presented in Table 5.4 also shows that the majority of L3 vehicles reported an engine displacement of between 501 and 750 cc (39.3%). The next most frequently reported L3 vehicle engine displacement was 51 to 125 cc (16.3% of all L3 vehicles).

Table 5.4: Engine displacement by PTW legal category

	L1 vehicles		L3 vehicles		Total	
	Frequency	Percent of L1	Frequency	Percent of L3	Frequency	Percent
up to 50	394	99.0	0	0.0	394	42.7
51 to 125	4	1.0	85	16.3	89	9.7
126 to 250	0	0.0	37	7.1	37	4.0
251 to 500	0	0.0	56	10.7	56	6.1
501 to 750	0	0.0	206	39.3	206	22.4
751 to 1000	0	0.0	80	15.3	80	8.7
1001 or more	0	0.0	58	11.1	58	6.3
Unknown	0	0.0	1	0.2	1	0.1
Total	398	100.0	523	100.0	921	100.0

Table 5.5 indicates the predominating PTW colour of the 921 cases. The main PTW colour was determined from the view point of the OV whenever possible. For single vehicle accidents, PTW colour was determined based upon a visual inspection of the vehicle.

This variable was coded for each case in order to identify any potential relationships between PTW colour and conspicuity. The results indicate that the majority of PTWs were black in colour, followed by red and blue. When compared with the exposure data, only the white PTWs were found to be over-represented when compared to the accident data ($p < .05$).

Table 5.5: Predominating PTW colour

	Accident data		Exposure data	
	Frequency	Percent	Frequency	Percent
White	65	7.1	44	4.8
Yellow	45	4.9	38	4.1
Black	228	24.8	213	23.1
Red	166	18.0	174	18.9
Blue	175	19.0	210	22.7
Green	54	5.9	61	6.6
Silver, grey	97	10.5	115	12.5
Orange	16	1.7	9	1.0
Brown, tan	13	1.4	2	0.2
Purple	26	2.8	24	2.6
Gold	1	0.1	6	0.7
Chrome, metallic	1	0.1	0	0.0
Other	4	0.4	0	0.0
Unknown / no dominating colour	30	3.3	27	2.8
Total	921	100.0	923	100.0

A summary of the different braking systems found on the 921 PTWs involved in this research is presented in Table 5.6. The majority of the PTWs were reported as having a conventional braking system that did not include either an anti-lock braking system (ABS) or a combined braking system (CBS). Twenty of the accident involved PTWs were reported as having a CBS braking system while four PTWs were reported as having an ABS braking system. Only two accident case PTWs were reported as having both an ABS and CBS braking system.

When compared to the exposure data there were only 4 reported cases of PTWs with ABS in the MAIDS database while there were 22 reported cases of PTWs with ABS in the exposure population. It was reported by the German team that some exposure data sampling was done at rider group meetings where there was a high percentage of ABS equipped PTWs (e.g. a BMW rider group meeting). For this reason, the validity of the exposure data for this particular variable is questionable and no statistical comparison can be made between the accident data and the exposure data.

Table 5.6: Brake system configuration

	Accident data		Exposure data	
	Frequency	Percent	Frequency	Percent
No ABS, CBS	893	97.0	869	94.2
CBS only, no ABS	20	2.2	26	2.8
ABS	4	0.4	22	2.4
ABS and CBS	2	0.2	5	0.5
Unknown	2	0.2	1	0.1
Total	921	100.0	923	100.0

Collision dynamics

Each of the 921 accidents collected within the MAIDS research program were reconstructed in order to determine the pre-crash, crash and post crash speeds and

motions of all vehicles involved. This effort involved a review of the vehicle mechanical factors, a review of the environment in which the accident took place, and a review of the witness statements. A detailed analysis of all vehicles was then conducted in order to determine the pre-crash and crash speeds of all vehicles. Conventional accident reconstruction techniques were then applied to determine vehicle speeds and motions during all phases of the accident. A summary of the results of these analyses is presented in this section.

All investigators were trained to identify the precipitating event because this is the most important moment in the accident sequence. The precipitating event is defined as the “failure or manoeuvre that immediately led to the accident.” All calculations and motion descriptions were then made relative to that precipitating event. For example, in a situation where a bus is travelling in a direction opposite to the PTW and makes a left turn in front of the PTW, the precipitating event would be that moment when the bus violates the right of way of the PTW. Any motion of the PTW or the bus driver would be explained relative to the precipitating event (i.e., the violation of the right of way).

Table 5.7 describes the PTW pre-crash motion prior to the precipitating event. In 67.4% of accidents, the PTWs were travelling in a straight line. The next most frequent pre-crash motions were negotiating a bend at constant speed (12.1%, 111 of all cases), and performing a passing manoeuvre on the left (5.8%, 53 of all cases).

Table 5.8 shows the pre-crash motion of the OV prior to the precipitating event.

Table 5.7: PTW pre-crash motion prior to precipitating event

	Frequency	Percent
Stopped in traffic, speed is zero	26	2.8
Moving in a straight line, constant speed	452	49.1
Moving in a straight line, throttle off	39	4.2
Moving in a straight line, braking	22	2.4
Moving in a straight line, accelerating	108	11.7
Turning right, constant speed	7	0.8
Turning right, throttle off	1	0.1
Turning right, accelerating	1	0.1
Turning left, constant speed	6	0.7
Turning left, throttle off	3	0.3
Turning left, braking	3	0.3
Turning left, accelerating	2	0.2
Stopped at roadside, or parked	1	0.1
Making Y-turn left	1	0.1
Changing lanes to left	9	1.0
Changing lanes to right	10	1.1
Merging to left	1	0.1
Entering traffic from right shoulder, median, or parked	2	0.2
Passing manoeuvre, passing on right	3	0.3
Passing manoeuvre, passing on left	53	5.8
Travelling wrong way, against opposing traffic	8	0.9
Stripe-riding, filtering forward between lanes, longitudinal motion	1	0.1
Filtering forward between lanes, both longitudinal and lateral motion	3	0.3
Collision avoidance manoeuvre to avoid a different collision	7	0.8
Negotiating a bend, constant speed	111	12.1
Negotiating a bend, throttle off	10	1.1
Negotiating a bend, braking	12	1.3
Negotiating a bend, accelerating	14	1.5
Other	5	0.5
Total	921	100.0

Table 5.8: OV pre-crash motion prior to precipitating event

	Frequency	Percent
Stopped in traffic, speed is zero	130	16.8
Moving in a straight line, constant speed	217	28.0
Moving in a straight line, throttle off	60	7.7
Moving in a straight line, braking	99	12.8
Moving in a straight line, accelerating	62	8.0
Turning right, constant speed	5	0.6
Turning right, throttle off	5	0.6
Turning right, braking	8	1.0
Turning right, accelerating	7	0.9
Turning left, constant speed	29	3.7
Turning left, throttle off	8	1.0
Turning left, braking	13	1.7
Turning left, accelerating	31	4.0
Stopped at roadside, or parked	6	0.8
Backing up, in a straight line	1	0.1
Backing up, steering left	1	0.1
Backing up, steering right	6	0.8
Making U-turn left	12	1.5
Changing lanes to left	8	1.0
Changing lanes to right	2	0.3
Entering traffic from right shoulder, median, or parked	15	1.9
Entering traffic from left shoulder, median, or parked	2	0.3
Leaving traffic, turn out to right	2	0.3
Passing manoeuvre, passing on right	1	0.1
Passing manoeuvre, passing on left	10	1.3
Travelling wrong way, against opposing traffic	2	0.3
Other	21	2.7
Unknown	15	1.9
Total	778	100.0

Figure 5.3 indicates the distribution of the PTW travelling speed just prior to the precipitating event. The greatest percentage of travelling speeds were between 30 km/h and 60 km/h. This was expected since most of the accidents took place in an urban environment, with typical roadway speed limits of 30 to 60 km/h. The data shown in Figure 5.4 may be found in Annex C, Table C.8.

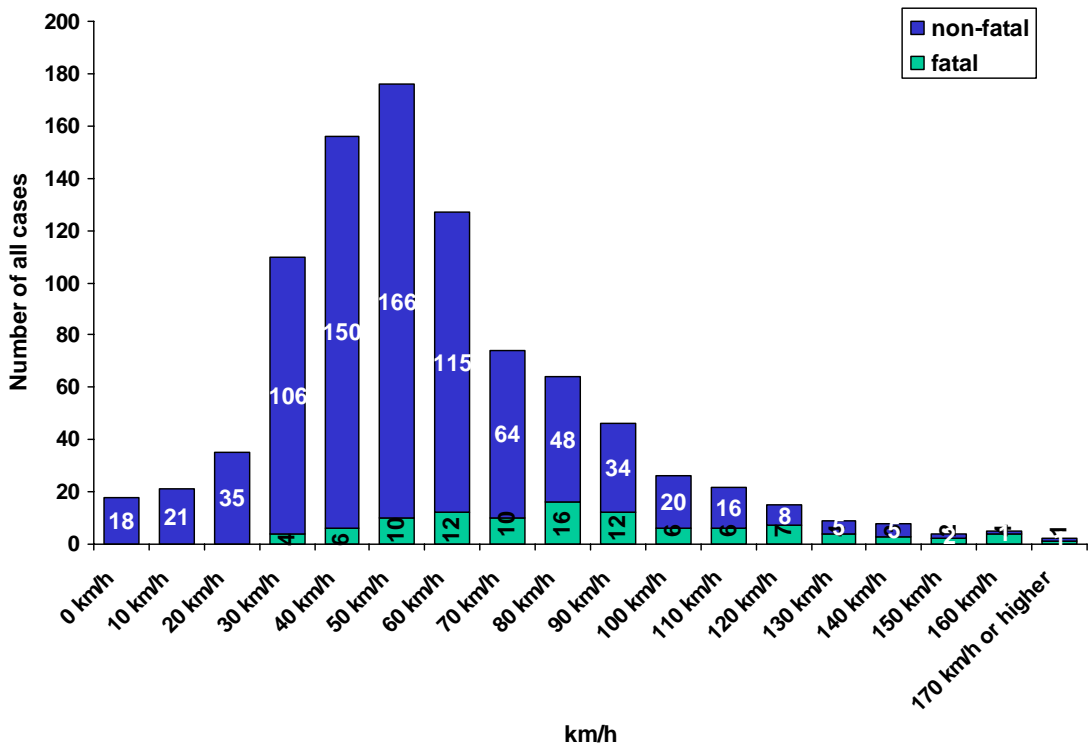

Figure 5.3: Comparison of travelling speed for fatal and non fatal cases (all accidents)

Figure 5.3 shows that there is a trend towards higher travelling speeds in PTW accidents involving fatalities.

Figure 5.4 indicates the cumulative percentage distribution of the PTW travelling speed for all accidents. The median travelling speed was found to be 49 km/h. The range of travelling speeds was found to be between 0 km/h and 185 km/h.

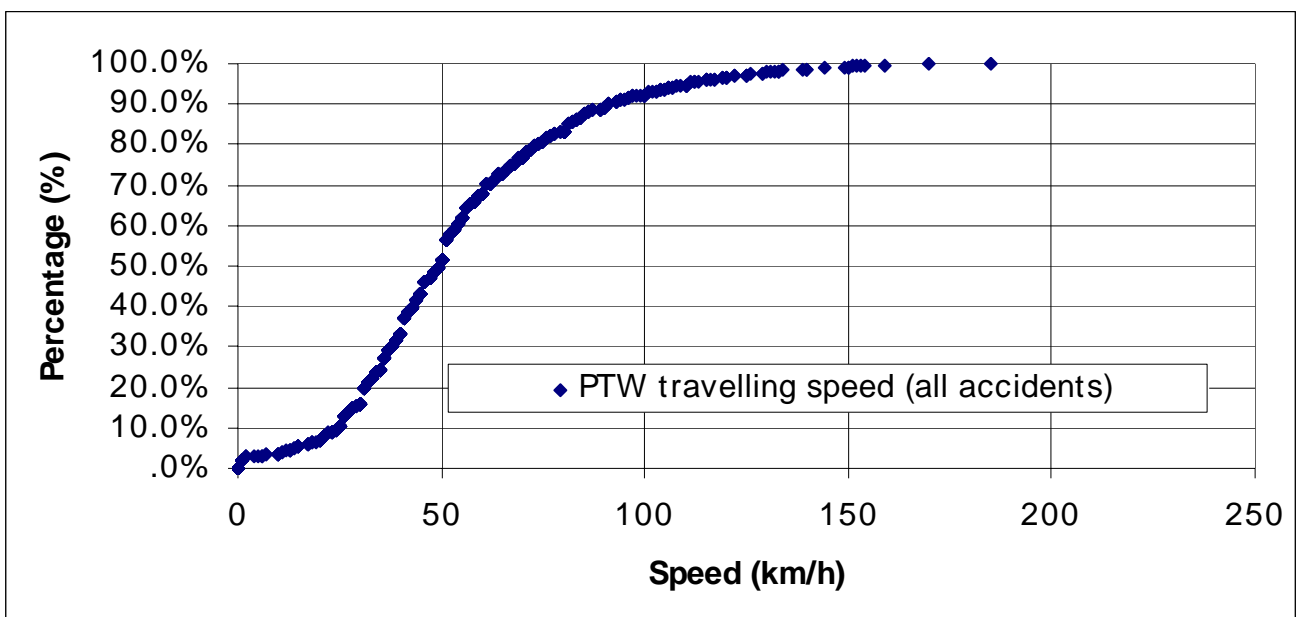

Figure 5.4: Travelling speed (all PTW accidents)

Table 5.9 shows the PTW travelling speed for single vehicle accidents. These are accidents which do not involve an OV. The largest percentage of these accidents was

found to have travelling speeds of between 40 km/h and 70 km/h, which is higher than the travelling speeds for all PTW accidents. Twenty one percent of single vehicle accidents were found to have travelling speeds of over 100 km/h.

Table 5.9: PTW travelling speed (single vehicle accidents)

	Frequency	Percent
20 km/h	3	2.1
30 km/h	11	7.7
40 km/h	21	14.7
50 km/h	18	12.6
60 km/h	16	11.2
70 km/h	16	11.2
80 km/h	15	10.5
90 km/h	10	7.0
100 km/h or higher	31	21.7
Unknown	2	1.4
Total	143	100.0

Table 5.10 shows the PTW travelling speed for all PTW cases in which the single vehicle accidents have been excluded. Over 65.3% of the accidents were found to have travelling speeds between 30 km/h and 60 km/h. Only 6.3% of all accidents were reported to have travelling speeds of 100 km/h or higher.

Table 5.10: PTW travelling speed (single vehicle accidents excluded)

	Frequency	Percent
0 km/h	29	3.7
10 km/h	19	2.4
20 km/h	45	5.8
30 km/h	118	15.2
40 km/h	148	19.0
50 km/h	154	19.9
60 km/h	87	11.2
70 km/h	57	7.3
80 km/h	45	5.8
90 km/h	26	3.3
100 km/h or higher	49	6.3
Unknown	1	0.1
Total	778	100.0

Table 5.11 presents the distribution of OV travelling speeds. The data indicates that the majority of OVs (i.e., 73.8%) were travelling at a speed of 40 km/h or less at the time of the precipitating event. Twenty percent of all OVs were stationary at the time of the precipitating event.

Table 5.11: OV travelling speed

	Frequency	Percent
0 km/h	143	18.4
10 km/h	118	15.2
20 km/h	133	17.1
30 km/h	95	12.2
40 km/h	85	10.9
50 km/h	64	8.2
60 km/h	42	5.4
70 km/h	21	2.7
80 km/h	18	2.3
90 km/h	11	1.4
100 km/h or higher	18	2.3
Unknown	30	3.9
Total	778	100.0

For all accidents involving an OV, the cumulative percentage distribution of the OV travelling speed is presented in Figure 5.5. The data indicates that the range of OV travelling speed is between 0 and 202 km/h. The median OV travelling speed was found to be 16 km/h.

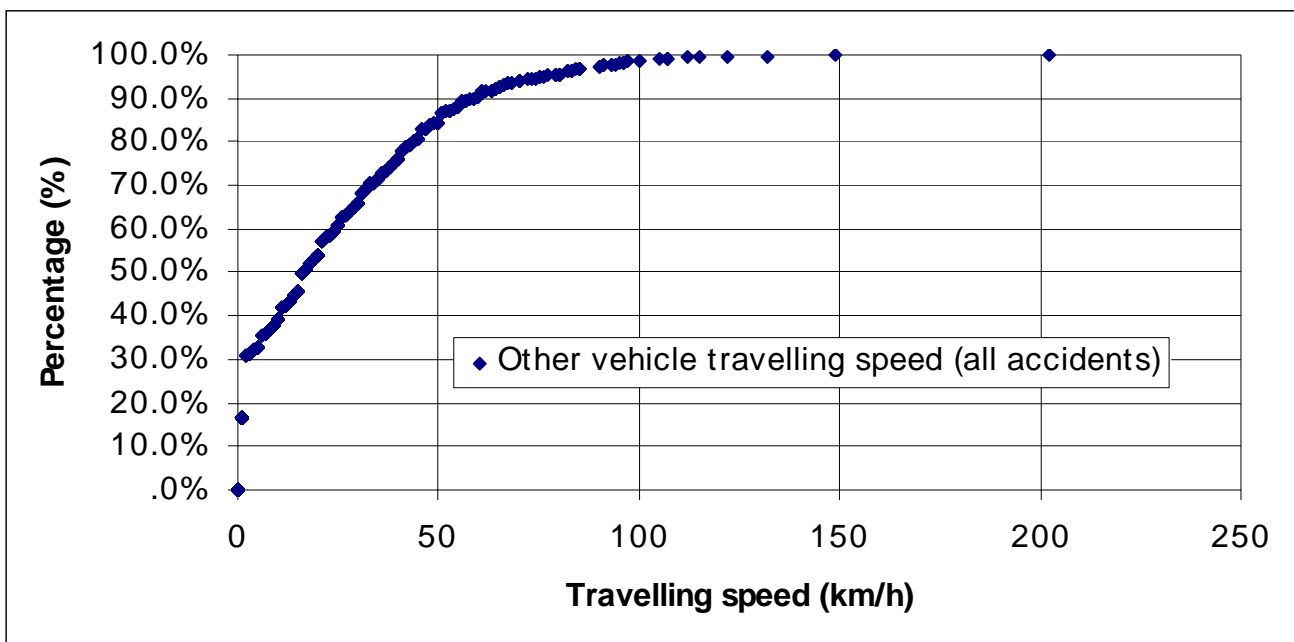

Figure 5.5: OV travelling speed (all accidents)

As part of the detailed reconstruction of each accident, all investigators coded the motion of the PTW immediately after the precipitating event and prior to the impact. Table 5.14 describes the distribution of these PTW pre-crash motions. The data indicate that 63.7% all accidents were travelling in a straight line after the precipitating event. Twenty percent of the PTW riders were travelling in a straight line and braking.

Table 5.12: PTW pre-crash motion after precipitating event

	Frequency	Percent
Stopped in traffic, speed is zero	6	0.7
Moving in a straight line, constant speed	289	31.4
Moving in a straight line, throttle off	41	4.5
Moving in a straight line, braking	175	19.0
Moving in a straight line, accelerating	81	8.8
Turning right, constant speed	6	0.7
Turning right, throttle off	7	0.8
Turning right, braking	5	0.5
Turning right, accelerating	1	0.1
Turning left, constant speed	14	1.5
Turning left, throttle off	5	0.5
Turning left, braking	14	1.5
Turning left, accelerating	16	1.7
Stopped at roadside, or parked	1	0.1
Making U-turn left	1	0.1
Changing lanes to left	8	0.9
Changing lanes to right	13	1.4
Merging to left	2	0.2
Merging to right	2	0.2
Leaving traffic, turn out to right	2	0.2
Passing manoeuvre, passing on right	6	0.7
Passing manoeuvre, passing on left	56	6.1
Crossing opposing lanes of traffic	5	0.5
Travelling wrong way, against opposing traffic	9	1.0
Stripe-riding, filtering forward between lanes, longitudinal motion	1	0.1
Filtering between lanes, lateral motion, only	1	0.1
Filtering forward between lanes, both longitudinal and lateral motion	3	0.3
Collision avoidance manoeuvre to avoid a different accident	8	0.9
Negotiating a bend, constant speed	54	5.9
Negotiating a bend, throttle off	22	2.4
Negotiating a bend, braking	29	3.1
Negotiating a bend, accelerating	9	1.0
Other	28	3.0
Unknown	1	0.1
Total	921	100.0

Figure 5.6 shows the line of sight to the OV as seen from the PTW rider at the time of the precipitating event. The data shows that 90% of all OVs were in front of the PTW rider at the time of the precipitating event (i.e., very few OVs appear to the sides or to the rear of the PTW rider).

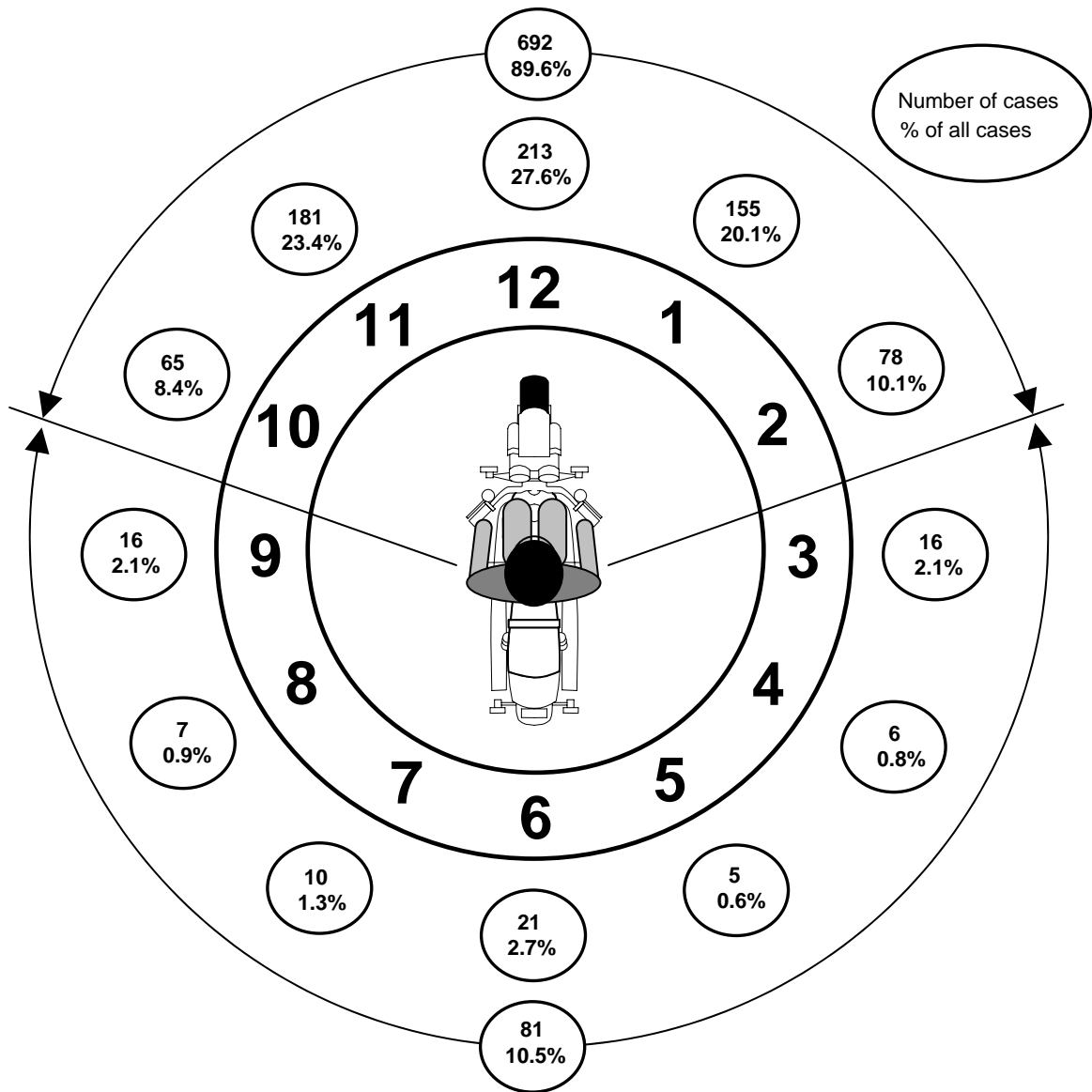

Figure 5.6: PTW line of sight to OV
 (Note: There are 5 cases in which the line of sight to the OV was unknown)

Table 5.13 shows the motions of the OV after the precipitating event. The data indicates that 31.6% of OVs were turning left after the precipitating event.

Table 5.13: OV pre-crash motion after precipitating event

	Frequency	Percent
Stopped in traffic, speed is zero	29	3.7
Moving in a straight line, constant speed	100	12.9
Moving in a straight line, throttle off	19	2.4
Moving in a straight line, braking	89	11.5
Moving in a straight line, accelerating	90	11.6
Turning right, constant speed	13	1.7
Turning right, throttle off	6	0.8
Turning right, braking	21	2.7
Turning right, accelerating	24	3.1
Turning left, constant speed	61	7.8
Turning left, throttle off	17	2.2
Turning left, braking	41	5.3
Turning left, accelerating	127	16.3
Stopped at roadside, or parked	1	0.1
Backing up, in a straight line	1	0.1
Backing up, steering left	3	0.4
Backing up, steering right	4	0.5
Making U-turn left	31	4.0
Making Y-turn left	4	0.5
Changing lanes to left	14	1.8
Changing lanes to right	9	1.2
Merging to left	1	0.1
Merging to right	1	0.1
Entering traffic from right shoulder, median, or parked	13	1.7
Entering traffic from left shoulder, median, or parked	2	0.3
Passing maneuver, passing on left	8	1.0
Crossing opposing lanes of traffic	1	0.1
Travelling wrong way, against opposing traffic	8	1.0
Other	25	3.2
Unknown	15	1.9
Total	778	100.0

The line of sight to the PTW as seen by the OV driver is presented in Figure 5.7. The data indicates that the majority of PTWs appear in front of the OV at the time of the precipitating event. Very few PTWs appear to the sides of the OV.

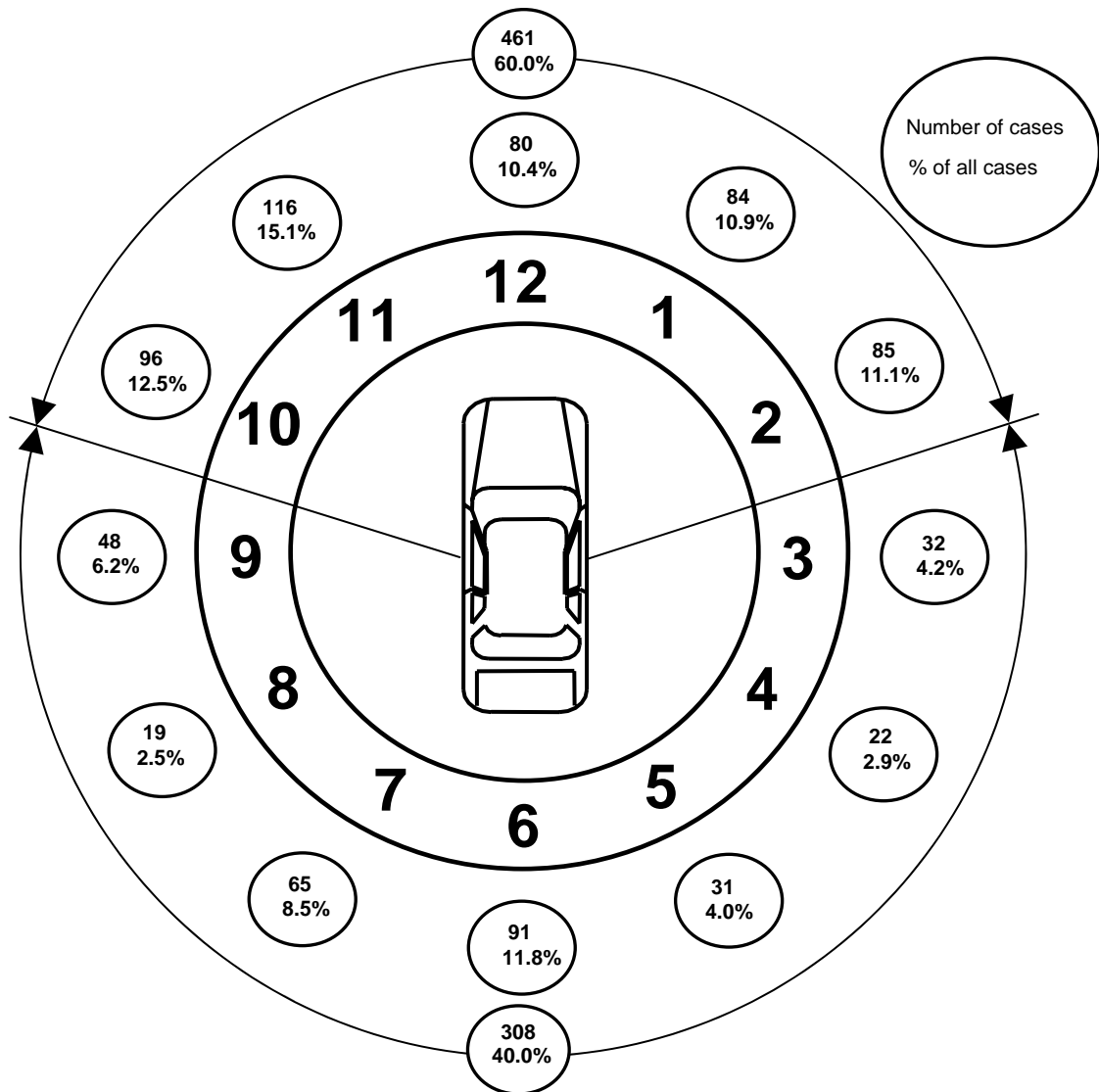

Figure 5.7: OV line of sight to PTW
 (Note: there were 9 cases in which the line of sight to the PTW was not known)

Table 5.14 indicates the distribution of PTW impact speeds for all accidents. In cases of single vehicle accidents, this represents the forward impact speed of the PTW at the time the PTW either struck the ground or some other environmental object (e.g., lamp post, etc.). In cases of PTW/OV collisions, the data represents the impact speed at the time of the collision between the OV and the PTW.

The data indicates that 74.8% of PTW crashes occurred at speeds below 50 km/h. Only 5.4% of impacts were at speeds of 100 km/h or higher.

Table 5.14: PTW impact speed (all accidents)

	Frequency	Percent
0 km/h	14	1.5
10 km/h	44	4.8
20 km/h	124	13.4
30 km/h	194	21.1
40 km/h	185	20.1
50 km/h	128	13.9
60 km/h	70	7.6
70 km/h	45	4.9
80 km/h	40	4.3
90 km/h	25	2.7
100 km/h or higher	50	5.4
Unknown	2	0.2
Total	921	100.0

Table 5.15 indicates the distribution of PTW impact speed for single vehicle accidents. The data suggests that in general the impact speeds for single vehicle accidents were higher than for accidents that involved an OV.

Table 5.15: PTW impact speed - single vehicle accidents only

	Frequency	Percent
Under 10 km/h	1	0.7
10 km/h	2	1.4
20 km/h	7	4.9
30 km/h	29	20.1
40 km/h	13	9.1
50 km/h	28	19.7
60 km/h	17	11.9
70 km/h	9	6.3
80 km/h	8	5.6
90 km/h	9	6.3
100 km/h or higher	18	12.6
Unknown	2	1.4
Total	143	100.0

When single vehicle accidents are removed from the dataset, 78.3% of PTW impact speeds were found to be below 50 km/h as shown in Table 5.16.

Table 5.16: PTW impact speed (single vehicle accidents excluded)

	Frequency	Percent
0 km/h	13	1.7
10 km/h	42	5.4
20 km/h	117	15.0
30 km/h	165	21.2
40 km/h	172	22.1
50 km/h	100	12.9
60 km/h	53	6.8
70 km/h	36	4.6
80 km/h	32	4.1
90 km/h	16	2.1
100 km/h or higher	32	4.1
Total	778	100.0

Table 5.17 shows the OV impact speed for all cases involving a collision with a PTW. The data indicates that in **76.2%** of all collisions that involve an OV, the impact speed was 30 km/h or less.

Table 5.17: OV impact speed (all accidents)

	Frequency	Percent
0 km/h	101	13.0
10 km/h	172	22.0
20 km/h	223	28.6
30 km/h	98	12.6
40 km/h	52	6.7
50 km/h	45	5.8
60 km/h	20	2.6
70 km/h	17	2.2
80 km/h	14	1.8
90 km/h	9	1.2
100 km/h or higher	14	1.8
Unknown	13	1.7
Total	778	100.0

To better understand the accident speed characteristics of different PTW types, the data were divided into the L1 and L3 vehicle categories. Table 5.18 shows the reconstructed speeds for all the L1 accidents. The median L1 travelling speed was found to be less than 37 km/h. The range of L1 travelling speeds was between 0 km/h and 82 km/h. The median L1 impact speed was found to be 31.0 km/h and the average confidence interval or accuracy value for impact speed was + or – 4 km/h.

The OV median travelling speed for L1 accidents was 24.0 km/h and the median OV impact speed was 19.0 km/h. The standard deviation was quite high for both of these values (i.e., 24.0 km/h and 20.8 km/h respectively) because of the wide variation in OV travelling and impact speeds.

Table 5.18: Travelling and impact speeds for L1 vehicle accidents

	L1 vehicle travelling speed	L1 vehicle impact speed	OV travelling speed	OV impact speed
Number of cases	396	397	353	351
Average speed (km/h)	36.8	31.7	27.4	24.6
Median speed (km/h)	37.0	31.0	24.0	19.0
Standard deviation (+/- km/h)	15.1	14.3	24.1	20.8
Minimum speed (km/h)	0	0	0	0
Maximum speed (km/h)	82	82	122	122
Average confidence interval (+/- km/h)	4.5	4.1	3.3	4.1

(Note: All cases in which the speed was unknown have been removed from this analysis)

Table 5.19 shows the speed values for L3 vehicles. The data indicates that the median travelling speed for L3 vehicles was 60 km/h with a median impact speed of 48.0 km/h. The range of L3 vehicle travelling speeds was between 0 km/h and 185 km/h and the range of L3 vehicle impact speeds was between 0 km/h and 170 km/h.

The OV median travelling speed for the L3 category was 21.0 km/h whilst the median impact speed was 20.0 km/h. Once again there was a high variability in the speed computations (i.e., standard deviations of 27.5 km/h and 23.9 km/h respectively). The minimum travelling and impact speeds were 0 km/h while the maximum travelling speed was 202 km/h and the maximum impact speed was 175 km/h.

Table 5.19: Travelling and impact speeds for L3 vehicle accidents

	L3 vehicle travelling speed	L3 vehicle impact speed	OV travelling speed	OV impact speed
Number of cases	522	522	396	389
Average speed (km/h)	65.3	53.6	29.1	26.3
Median speed (km/h)	60.0	48.0	21.0	20.0
Standard deviation (+/- km/h)	30.8	29.4	27.5	23.9
Minimum speed (km/h)	0	0	0	0
Maximum speed (km/h)	185	170	202	175
Average confidence interval (+/- km/h)	6.6	6.6	4.5	3.7

(Note: All cases in which the speed was unknown have been removed from this analysis)

A comparison of the travelling speed and impact speed for all PTW categories typically indicates a shift in the speed distribution. This means that in many cases, the PTW rider made some attempt at collision avoidance by reducing the speed of the PTW immediately prior to the impact.

In order to describe the collision configuration and the orientation of the PTW and OV at the time of impact, the relative angle between the PTW and the OV was determined. Figure 5.8 shows the coding convention.

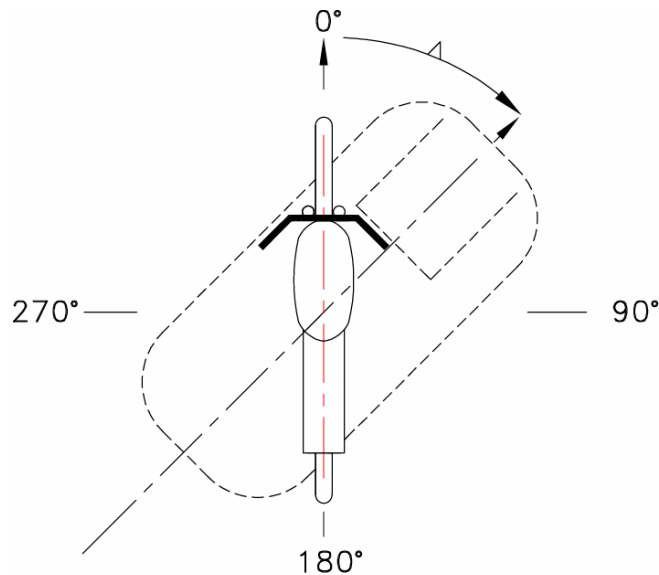

Figure 5.8: Relative heading angle

The relative heading angle represents the angle between the PTW and the OV at the time of contact, expressed as a positive angle, clockwise from the vertical. It does not incorporate any pre-crash motion of either vehicle. The convention for the identification of the relative heading angle was the same as that used in ISO 13232 – Motorcycles – test and analysis procedures for research evaluation of rider crash protective devices fitted to motorcycles (ISO, 2002), where zero degrees corresponds to both vehicles being pointed in the same direction.

Figure 5.9 shows the distribution of the relative heading angle at the time of impact and that there was a wide diversity of PTW-OV impact configurations, as shown by the wide range of equally distributed relative heading angles. The most frequent relative heading angle was between 337.5 and 22.5 degrees (25.1% or 195 of all cases involving a PTW and OV). The second most frequent relative heading angle was between 67.6 and 112.5 (16.8% or 131 cases).

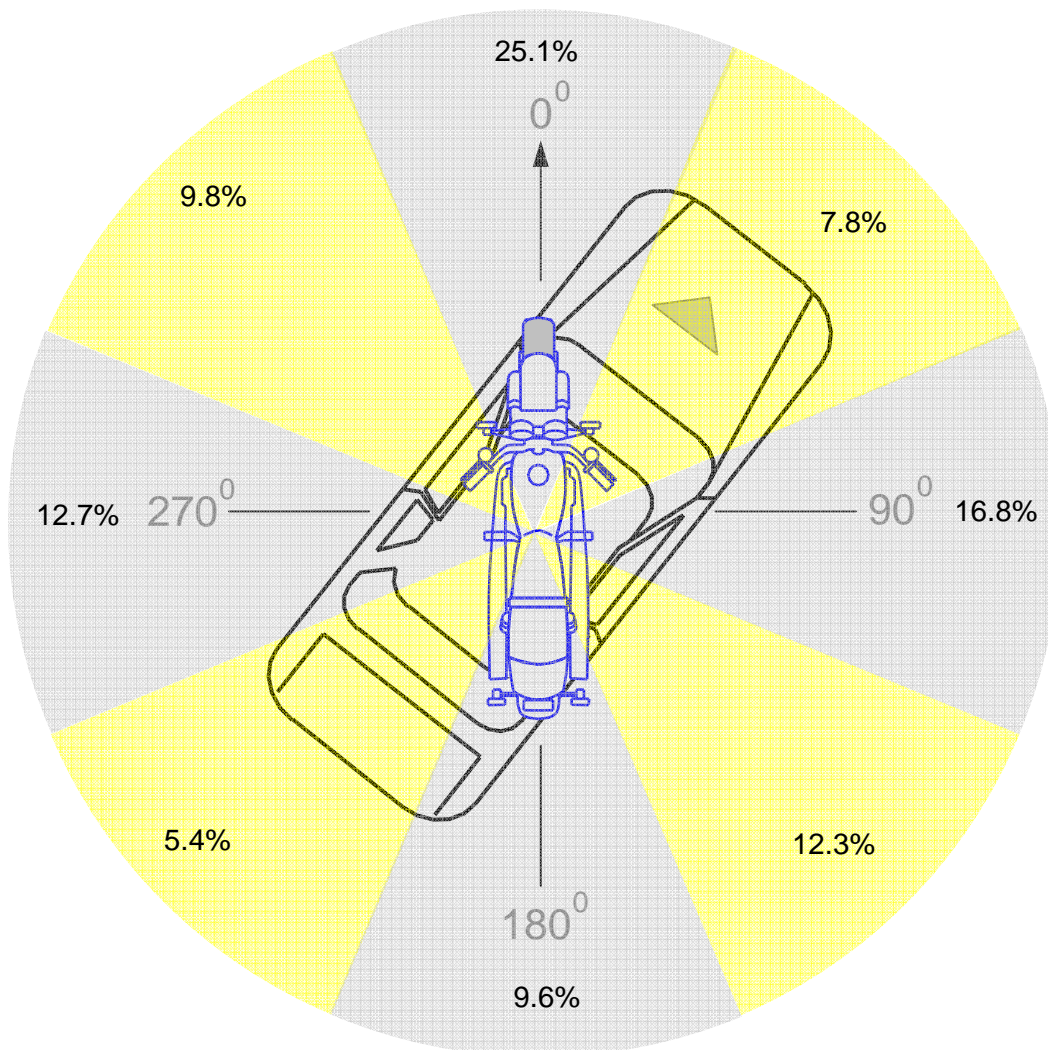

Figure 5.9: Distribution of relative heading angles for PTW to OV collisions

The in-depth analysis of each accident included a detailed reconstruction of all collision avoidance manoeuvres attempted by the PTW rider and the OV driver. This information was obtained by a detailed scene inspection (i.e., to identify skid marks), a detailed vehicle inspection (i.e., to identify skid patches on tyres) and a complete interview of all persons involved in the accident and persons who may have witnessed the accident. Table 5.20 shows the distribution of these collision avoidance manoeuvres by the PTW rider.

The data indicates that braking was a collision avoidance response performed **49.3%** of the time (n=664). In other cases, the rider attempted to avoid the accident by swerving (**16.2%** of all collision avoidance manoeuvres, n=218). Accelerating, using the horn, flashing the headlamp, dragging the feet or jumping from the PTW was used as a collision avoidance manoeuvre in very few cases.

The data indicates that in almost one-third of all cases, the PTW rider did not attempt to perform any collision avoidance manoeuvre. This may be due to a failure on the part of the PTW rider and it may also be due to an inadequate amount of time available to engage in any kind of collision avoidance. Further investigations of the accident dynamics for each case would provide such information.

Table 5.20: Collision avoidance performed by PTW rider
(Note that frequency total > 921 because of multiple responses)

	Frequency	Percent
No collision avoidance attempted	362	26.9
Braking	664	49.3
Swerve	218	16.2
Accelerating	17	1.3
Use of horn, flashing headlamp	18	1.3
Drag feet, jump from PTW	9	0.7
Other	32	2.4
Unknown	26	1.9
Total	1346	100.0

As part of the accident reconstruction and scene inspection, the investigators were often able to determine if there was some type of loss of control on the part of the PTW rider during a collision avoidance manoeuvre. Table 5.21 provides the distribution of the loss of control modes for all MAIDS cases. There was no loss of control reported in 68.1% of all cases. When there was loss of control, it was mostly related to braking and a subsequent change in vehicle dynamics (13.1% of all cases, 41.0% of all cases involving loss of control).

Table 5.21: Loss of control mode (PTW rider)

	Frequency	Percent
No loss of control	626	68.1
Capsize, or fall over	49	5.3
Braking slide-out, low side	94	10.2
Braking slide-out, high side	27	2.9
Cornering slide out, low side	27	2.9
Cornering slide out, high side	2	0.2
Ran wide on turn, ran off road, under cornering	45	4.9
Lost wheelie	1	0.1
Low speed wobble	4	0.4
High speed wobble	5	0.5
Weave, no pitch	1	0.1
Pitch weave, low speed	3	0.3
Pitch weave, high speed cornering	1	0.1
End-over, endo, reverse wheelie	6	0.7
Continuation, no control actions	7	0.8
Other	15	1.6
Unknown	8	0.9
Total	921	100.0

Table 5.22 provides information regarding the different loss of control modes for single vehicle accidents (i.e., an accident that only involved the PTW and PTW rider). The physical inspection of the PTW identified scrape marks, skid patches and other evidence for the reconstruction. From this inspection, a detailed vehicle dynamics analysis was performed for each case and a complete understanding of the pre-crash vehicle dynamics was generated.

As expected, running off the roadway was the most frequently reported loss of control mode (34 cases, 23.4% of all single vehicle accidents). This was followed by cases of braking slide-outs of the PTW (14.5% of all single vehicle cases) and PTW capsized (10.3% of all single vehicle accidents).

Table 5.22: Loss of control mode (single vehicle accidents)

	Frequency	Percent
No loss of control	25	17.2
Capsized, or fall over	15	10.3
Braking slide-out, low side	21	14.5
Braking slide-out, high side	4	2.8
Cornering slide out, low side	16	11.0
Cornering slide out, high side	2	1.4
Ran wide on turn, ran off road, under cornering	34	23.4
Lost wheelie	1	0.7
Low speed wobble	2	1.4
High speed wobble	3	2.1
Weave, no pitch	1	0.7
Pitch weave, low speed	2	1.4
Pitch weave, high speed cornering	1	0.7
End-over, endo, reverse wheelie	4	2.8
Continuation, no control actions	2	1.4
Other	8	5.5
Unknown	4	2.8
Total	145	100.0

Each investigator was required to determine the main reason for the failed collision avoidance. This was requested because it is generally accepted that in certain accident situations, there is simply not enough time available to complete any type of collision avoidance manoeuvre. Table 5.23 shows that in 32.2% of the PTW cases and in 21.1 of the OV cases, there was failed collision avoidance due to inadequate time available to complete the collision avoidance action.

Table 5.23: Reason for failed collision avoidance

	PTW rider		OV driver	
	Frequency	Percent	Frequency	Percent
Decision failure, wrong choice of evasive action	69	7.5	26	3.4
Reaction failure, poor execution of evasive action	41	4.5	9	1.2
Inadequate time available to complete avoidance action	297	32.2	164	21.1
Loss of control in attempting collision avoidance	129	14.0	3	0.4
Other	6	0.7	6	0.8
Not applicable, no OV or no evasive action taken	362	39.3	545	70.1
Unknown	17	1.8	25	3.2
Total	921	100.0	778	100.0

The in-depth accident analysis included an evaluation of the rider's familiarity with the controls of the accident PTW. Table 5.24 indicates that in 3.7% of all MAIDS cases (n=34) the investigators came to the conclusion that the PTW rider was not familiar with the controls of the accident PTW.

Table 5.24: Control unfamiliarity (PTW rider)

	Frequency	Percent
Yes	34	3.7
No	873	94.8
Unknown	14	1.5
Total	921	100.0

Table 5.25 presents the distribution of the collision avoidance manoeuvres attempted and performed by the OV driver. The data indicates that in 537 accidents, there was no collision avoidance manoeuvre attempted or performed by the OV driver. For those cases where a collision avoidance manoeuvre was attempted, braking was the most frequently reported manoeuvre, occurring in 23.6% of all collision avoidance manoeuvres performed by the OV driver.

Table 5.25: Collision avoidance manoeuvre performed by OV driver

	Frequency	Percent
No collision avoidance action	537	64.9
Braking	195	23.6
Swerve	71	8.6
Accelerating	6	0.7
Counter-steering	2	0.2
Cornering	0	0.0
Other	2	0.2
Unknown	15	1.8
Total	828	100.0

(Note that frequency total > 778 because of multiple responses)

The complete reconstruction of the accident included an analysis of the post-crash motions of the PTW, the PTW rider, the PTW passenger and the OV. Table 5.26 indicates that 43.6% of PTWs skidded and/or slid to rest from the point of impact.

Table 5.26: Post crash motion of the PTW

	Frequency	Percent
Stopped at point of impact (POI); point of rest (POR) and POI coincide	29	3.1
Stopped within 2 m of POI	103	11.2
Rolled on wheels from POI to POR	21	2.3
Rolled on wheels from POI, then impacted other object at POR	16	1.7
Vehicle rollover from POI to POR	4	0.4
Skidded, slid from POI to POR	401	43.6
Skidded, slid from POI, then impacted other object at POR	123	13.4
Vaulted above ride height from POI, then rolled to POR	5	0.5
Vaulted above ride height from POI, then slid to POR	38	4.1
Vaulted above ride height from POI, then impacted object at POR	7	0.8
Run over at POI	1	0.1
Run over, dragged from POI to POR	12	1.3
Caught by or landed on OV; carried to POR	11	1.2
Entrapped with OV (other than run over); POR same as OV POR	25	2.7
Vehicles did not separate; PORs are the same for both vehicles	16	1.7
Spun or yawed, sliding from POI to POR	27	2.9
Other	76	8.3
Unknown	6	0.7
Total	921	100.0

Table 5.27 indicates that many PTW riders tumbled, rolled, or slid from the point of impact to the point of rest, with a small percentage impacting other objects at the point of rest. The other object was often found to be a kerb, a fence or a lamppost, which represent significant injury hazards to the PTW rider.

Table 5.27: Post crash motion, PTW rider motion

	Frequency	Percent
Stopped at POI; POR and POI coincide	18	2.0
Stopped within 2 m of POI	78	8.5
Tumbled and rolled from POI to POR	116	12.6
Tumbled and rolled from POI, then impacted object at POR	11	1.2
Slid from POI to POR	154	16.8
Slid from POI, then impacted other object at POR	40	4.3
Vaulted above ride height from POI, then rolled to POR	80	8.7
Vaulted above ride height from POI, then slide to POR	110	11.9
Vaulted above ride height from POI, then impacted other object At POR	30	3.3
Run over at POI	2	0.2
Run over, dragged from POI to POR	5	0.5
Caught by or landed on OV; carried to POR	41	4.5
Entangled with OV; POR same as OV POR	13	1.4
Did not separate from PTW, rode from POI to POR; POR same as PTW POR	98	10.6
Hit and run, departed scene immediately after collision	11	1.2
Other	62	6.7
Unknown	52	5.6
Total	921	100.0

There were a total of 79 MAIDS cases that included a passenger. Table 5.28 shows the post-crash passenger motion code. In 3.8% of cases, the passenger came to rest

within 2 m of the point of impact. Many passengers tumbled, rolled and/or slid from the point of impact to the point of rest.

Table 5.28: Post crash passenger motion code

	Frequency	Percent
Stopped within 2 m of POI	3	3.8
Tumbled and rolled from POI to POR	4	5.1
Tumbled and rolled from POI, then impact. object at POR	2	2.5
Slid from POI to POR	6	7.6
Slid from POI, then impacted other object at POR	1	1.3
Vaulted above ride height from POI, then rolled to POR	3	3.8
Vaulted above ride height from POI, then slide to POR	5	6.3
Vaulted above ride height from POI, then impacted object at POR	1	1.3
Caught by or landed on OV; carried to POR	1	1.3
Entangled with OV; POR same as ov POR	1	1.3
Other	7	8.9
Unknown	45	56.8
Total	79	100.0

Table 5.29 shows the distribution of the post-crash motion of the OV. In 45.3% of cases, the OV rolled on its wheels from the POI and then impacted another object at the point of rest. This other object was most frequently found to be the kerb at the side of the roadway. The next most frequently reported post-crash motion was rolling on the wheels from the point of impact to the point of rest (16.7% of all cases).

Table 5.29: Post crash OV motion

	Frequency	Percent
Stopped within 2 m of POI	72	9.3
Stopped at POI; POR and POI coincide	10	1.3
Rolled on wheels from POI to POR	131	16.7
Rolled on wheels from POI, then impacted other object at POR	353	45.3
Vehicle rollover from POI to POR	20	2.6
Skidded, slid from POI to POR	4	0.5
Skidded, slid from POI, then impacted other object at POR	72	9.3
Vaulted above ride height from POI, then rolled to POR	10	1.3
Vehicles did not separate; PORs are the same for both vehicles	27	3.5
Spun or yawed, sliding from POI to POR	11	1.4
Hit and run, driver departed with OV after collision	9	1.2
Driver departed after collision but OV still at scene	1	0.1
Other	28	3.6
Unknown	30	3.9
Total	778	100.0

Vehicle technical conditions at the time of accident

As reported above, each PTW involved in this data collection was given a detailed inspection in order to clearly determine the pre-crash condition of the PTW as well as its crash performance. For the L1 vehicles, an additional evaluation was performed to take note of any visible modifications to the engine/driveline. According to European law, the maximum speeds of L1 vehicles are design-restricted, in connection with their specific usage privileges. Table 5.30 indicates that in 17.8% of all cases that involved a L1 vehicle, there was some form of engine or driveline tampering.

Table 5.30: L1 vehicle tampering

	Accident data		Exposure data	
	Frequency	Percent	Frequency	Percentage
Yes	71	17.8	46	12.3
Not tampered or unknown if tampering was done	327	82.2	327	87.7
Total	398	100.0	373	100.0

In 1.1% of all MAIDS cases, there was a mechanical problem with the PTW (see Table 5.31). In two cases there was a power train problem with the PTW and in another two cases there were lighting problems with the PTW. There were also six other mechanical problems which could not be categorized. An example of one such reported mechanical problem was a seat latch which would not latch properly. Such problems were found during the detailed vehicle inspection following the accident. Often the PTW problem had no relationship to accident causation; therefore, the numbers presented in Table 5.31 (i.e., 35 PTW problems) are greater than those presented in Table 4.2 (i.e., 32 PTW problems that were accident contributing factors).

Table 5.31: Symptom of PTW problem

	Frequency	Percent
None	886	96.2
Power system	2	0.2
Electrical system	2	0.2
Other	6	0.7
Unknown	25	2.7
Total	921	100.0

The OV was inspected in great detail whenever possible. The frequency of reported OV mechanical problems was also quite low (i.e., under 2% of all reported cases). Table 5.32 indicates that the most frequently reported problem was a brake failure of the OV, occurring in 5 of the 778 cases that involved an OV.

Table 5.32: OV mechanical problem

	Frequency	Percent
None	703	90.4
Tyre or wheel failure	1	0.1
Brake failure	5	0.7
Steering failure	1	0.1
Electrical failure	3	0.4
Maintenance related mechanical problem	1	0.1
Unknown	64	8.2
Total	778	100.0

Findings on Vehicles

Vehicle Characteristics

- With the exception of the modified conventional street PTWs, no one style of vehicle was over-represented in the accident data.
- Engine displacement does not represent a risk factor in accident involvement.
- Only white PTWs were found to be over-represented in the accident data.
- Due to low frequencies in the accident and exposure samples and some questions regarding the validity of the ABS counts in the exposure sampling, no meaningful conclusions related to advanced braking systems could be made.

Collision Dynamics

- More than 60% of the PTWs and 55% of OVs were travelling in a straight line prior to the precipitating event and 64% continued in a straight line up to impact.
- PTW accidents occur in a wide variety of different impact configurations (i.e., many different relative heading angles).
- At the time of the precipitating event, 50% of all PTWs, 37% of PTWs in single vehicle collisions and 19.4% of PTWs in fatal accidents were travelling at 50 km/h or less.
- When the collision involved a PTW and an OV, at the time of the precipitating event, 82% of the OVs were travelling at 50 km/h or less.
- 90% of all OVs were to the front of the PTW rider and 60% of the PTWs were to the front of the OV, at the time of the precipitating event.
- 75% of all PTW impact speeds were under 50 km/h.
- 78% of PTW impact speeds were 50 km/h or below in multiple vehicle accidents, and 56% of PTW impact speeds were below 50 km/h in the case of single vehicle accidents.
- The OV impact speeds were under 50 km/h in 88.7% of the multiple vehicle collisions.
- L1 vehicle travelling speeds were under 37 km/h 50% of the time, the mean L1 impact speed was 30.7 km/h.
- In multiple vehicle crashes, 69.4% of the PTW operators attempted some sort of collision avoidance manoeuvre (42% by braking, 20% by swerving). 69% of the OV drivers attempted no collision avoidance manoeuvre.
- In 32.2% of the multiple vehicle collisions, there was no time available for the PTW rider to complete a collision avoidance manoeuvre.

Vehicle Technical Conditions

- Visual inspection showed some sort of tampering with the engine or driveline in 17.8% of L1 vehicles involved in accidents.
- 99% of all cases indicated no mechanical problems with the PTW or the OV, prior to the accident.

6.0 Environmental factors

Roadway types and condition

The environment for the PTW rider is quite different when compared to other forms of road transportation because PTWs and PTW riders are more sensitive to roadway conditions within the transportation environment. This section describes some of the findings with respect to the environmental factors in PTW accidents and for the purposes of analysis, the following definitions were used:

Motorway: a road specially designed and built for motor traffic, which does not serve property bordering on it, and which:

1. *Is provided, except at special points or temporarily, with separate carriageways for the two directions of traffic, separated from each other either by a dividing strip not intended for traffic or, exceptionally, by other means.*
2. *Does not cross at level with any road, railway or tramway track or footpath.*
3. *Is specially sign-posted as a motorway.*

Major arterial: Streets or roads designed for the greatest volumes of traffic and/or the highest permissible speeds in a given urban or rural area.

Minor arterial: Streets or roads designed for intermediate volumes of traffic and/or intermediate permissible speeds relative to all streets or roads in a given urban or rural area.

As presented in Table 3.8, the majority of accidents (666 cases, 72%) within the MAIDS database took place in an urban area. Approximately 25% of the remaining accidents took place in a rural area. The greatest number of accidents occurred on minor arterial roadways (51.6%) as shown in Table 6.1.

Table 6.1: Roadway type

	Frequency	Percent
Motorway	39	4.2
Major arterial	192	20.9
Minor arterial	475	51.6
Non-arterial, sub-arterial	126	13.8
Parking lot, parking area	4	0.4
Driveway	3	0.3
Round about or traffic circle	6	0.7
Overpass	2	0.2
Underpass	5	0.5
Dedicated bicycle or moped path separated from traffic roadway	51	5.5
Dedicated bicycle or moped path not separated from traffic roadway	3	0.3
Other	14	1.5
Unknown	1	0.1
Total	921	100.0

As described, all accident investigations included a complete examination of the pre-crash path for all accident involved vehicles. The roadway alignment was coded based upon the pre-crash path of the PTW and 70.3% of these roadways were found to be straight (647 of 921 cases). The remaining pre-crash paths were either curves or corners (as shown in Table 6.2). The pre-crash path for the OV was found to be straight in 76.9% of all cases (598 of 778 cases) and curved in 21.3% of the remaining cases (see Table 6.3).

Table 6.2: Roadway alignment (PTW)

	Frequency	Percent
Straight	647	70.3
Curve/corner	273	29.6
Other/unknown	1	0.1
Total	921	100.0

Table 6.3: Roadway alignment (OV)

	Frequency	Percent
Straight	598	76.9
curve/corner	166	21.3
Unknown	14	1.8
Total	778	100.0

The weather conditions at the time of the accident were most frequently dry (89.9%) and rain at the time of the accident was noted in 7.9% of all cases (see Table 6.4).

Table 6.4: Weather conditions at time of accident

	Frequency	Percent
No precipitation	828	89.9
Rain	73	7.9
Ice rain/snow	2	0.2
Other	2	0.2
Unknown	16	1.8
Total	921	100.0

The roadway was found to be dry and free of contamination in 84.7% of all accidents (Table 6.5) wet in 7.9% of all collected cases. Water was coded as a roadway contamination because of the negative effect that it could have upon PTW handling and braking capabilities. Ice, snow and mud were reported in 5 cases respectively and gravel or sand was reported in 23 cases, or 2.5% of all cases. These finding clearly illustrate the effect of roadway contamination risks in PTW accidents although this table does not indicate whether the contamination contributed to the accident. This is described in Section 4.0: Accident contributing factors.

Table 6.5: Roadway contamination

	Frequency	Percent
Dry	780	84.7
Water	73	7.9
Snow	2	0.2
Mud	3	0.3
Ice	5	0.5
Gravel sand	23	2.5
Oil	7	0.8
Other	26	2.9
Unknown	2	0.2
Total	921	100.0

The data collection protocol for each MAIDS case involved travelling to the accident scene to collect on-scene measurements as well as information about the physical environment. This provided a great deal of information regarding the roadway conditions for PTW riders. The accepted coding convention for all research teams participating in the MAIDS research program was to code the presence of any roadway conditions or defects along the pre-crash path of the PTW. This was done because PTWs are much more sensitive to roadway conditions than four wheel vehicles. Separate questions were coded to indicate whether or not these roadway conditions or defects were involved in the causation of the accident. Table 6.6 indicates that 70.4% of the roadways were normal and had no defects. Surface deterioration or damaged bitumen (i.e., broken or separated asphalt, cracks, etc.) was found on 26% of all roadways (14.1% + 11.9%). When the data for fatal PTW collisions was compiled, the results were found to be very similar (see Table 6.7).

Table 6.6: Roadway condition and defects

	Frequency	Percent
Normal/ no defects	648	70.4
Surface deteriorated	130	14.1
Bitumen	110	11.9
Tram/ train rails	9	1.0
Other interfering defects	23	2.5
Unknown	1	0.1
Total	921	100.0

Table 6.7: Roadway condition and defects (fatal accidents only)

	Frequency	Percent
Normal/ no defects	74	71.8
Surface deteriorated	14	13.6
Bitumen	14	13.6
Tram/ train rails	1	1.0
Other interfering defects	0	0.0
Painted markings	0	0.0
Total	103	100.0

The road surface was considered to be optimal in 56.0% of all cases collected (Table 6.8). An optimal coding was given to any roadway which was smooth and without significant bumps, dips, cracks or any condition which might affect the proper handling of a

PTW. The coding for the asphalt condition was based upon the visual inspection of the roadway at the time of the on-scene data collection; therefore, the condition of the roadway was assumed to be identical to the roadway condition at the time of the accident.

Table 6.8: Roadway condition

	Frequency	Percent
Asphalt, optimal condition	516	56.0
Asphalt, not optimal condition	318	34.5
Other than asphalt, optimal condition	50	5.4
Other than asphalt, non optimal condition	34	3.8
Unknown	3	0.3
Total	921	100.0

Roadside barriers were also investigated with respect to their contribution to PTW rider injury. It is understood that roadside barriers are designed to contain errant vehicles, to reduce the severity of off-road environmental collisions and to avoid collisions with opposing traffic at motorways. Whilst these roadside barriers work quite effectively for passenger cars, they present significant obstacles when struck by the PTW rider.

Each injury within the MAIDS database was coded with two environment or vehicle collision contact codes in order to better understand the sources of PTW rider injuries. To investigate barrier associated injuries, all injuries that were associated with a barrier or guard rail contact were identified. As shown in Figure 6.1, a total of 60 PTW rider injuries were associated with barrier contact. Twelve of these injuries were to the head and eight of these head injuries were categorised as severe or higher (e.g., AIS >3). One quarter of the injuries were found to be to the lower extremities and the majority of these lower extremity injuries were found to be minor and moderate in severity (e.g., abrasions, minor lacerations and contusions). There were five serious lower extremity injuries due to roadside barrier contact. The data shown in Figure 6.1 may be found in Annex C Table C.9.

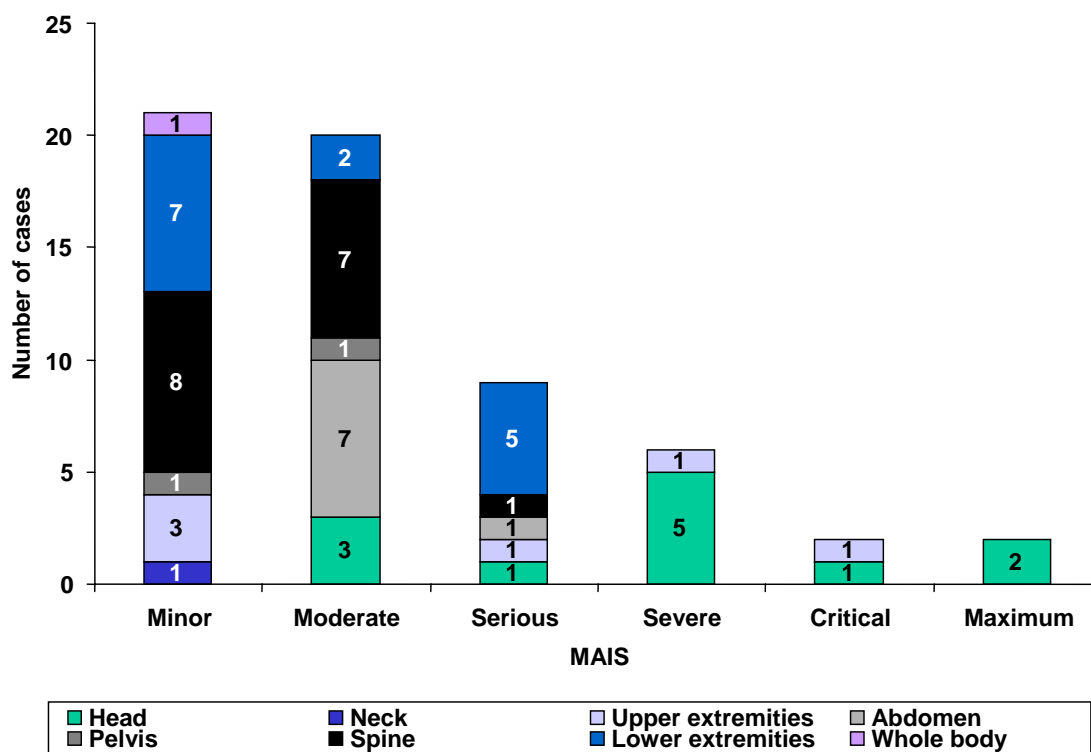

Figure 6.1: Roadside barrier injury summary

Traffic controls

Traffic controls along the pre-crash path of travel were coded by each of the research teams and are presented in Table 6.9. A traffic control was defined as any device, sign or object which controlled or regulated the flow of traffic (e.g., traffic control signals, priority signs, stop signs, etc.).

For the PTW pre-crash path, there was no traffic control reported in 64.7% of all cases. Table 6.10 shows that PTW riders violated traffic controls in 29.8% of cases in which a traffic control was present. There were 17 cases in which the team was unable to determine if the traffic control had been violated by the PTW rider.

Table 6.9: Traffic controls along PTW pre-crash path

	Frequency	Percent
None	596	64.7
Sign	55	6.0
Traffic control signal	190	20.6
Other	78	8.5
Unknown	2	0.2
Total	921	100.0

Table 6.10: Traffic control violated by PTW rider

	Frequency	Percent
No	235	25.6
Yes	73	7.9
Unknown if traffic control was present or if traffic control was violated	17	1.8
Not applicable, no traffic control present	596	64.7
Total	921	100.0

Traffic controls along the OV pre-crash path are reported in Table 6.11. Note that the distribution of traffic controls are not the same as the distribution of PTW controls because in many cases the PTW and the OV were not on the same pre-crash path.

Table 6.12 indicates that traffic controls were violated by OV drivers in 45.6% of cases where a traffic control was present. The figures show that the number of violations of traffic controls is lower for PTW riders (7.9%) compared to OV drivers (18.0%).

Table 6.11: Traffic controls along OV pre-crash path

	Frequency	Percent
None	411	52.8
Traffic control sign	134	17.2
Traffic control signal	173	22.3
Other	49	6.3
Unknown	11	1.4
Total	778	100.0

Table 6.12: Traffic controls violated by OV operator

	Frequency	Percent
No	199	25.6
Yes	140	18.0
Unknown	20	2.6
Not applicable, not traffic control present	419	53.8
Total	778	100.0

Findings on environmental factors

- 89.9% of the accidents took place on dry days.
- 84.7% of the time the roads were dry at the time of the accident.
- Road surfaces had defects in 30% of cases.
- Road surfaces were considered optimal in 61.4% of cases.
- Roadside barriers accounted for 60 PTW rider injuries.
- Where there was a traffic control, it was violated in 29.8% of cases by the PTW riders and in 45.6% of cases by the OV driver.

7.0 Human factors

One of the requirements of the in-depth analysis of each case was for the research team to interview each person who was involved in the PTW accident. Specific human factors information was collected regarding the rider's age, rider's licence qualification and the rider's experience on a PTW. All personal data collected during this study was obtained with the full consent of the PTW rider and OV driver. In the analysis of fatal cases, as much information as possible was collected from friends and relatives of the PTW rider. All data was sanitized in order to protect the privacy rights of all individuals who agreed to participate in the MAIDS project.

Table 7.1 provides information on the distribution of rider gender within the accident data and within the exposure data. There were 798 male riders who participated in the MAIDS study (86.6%) and 791 male riders who agreed to participate in the petrol station exposure data collection (85.7%). There were 123 females in the accident data and 132 females in the exposure populations. No significant differences were noted in either population, indicating that neither males nor females were under- or over-represented in the accident population.

Table 7.1: PTW rider gender

	Accident data		Exposure data	
	Frequency	Percent	Frequency	Percent
Male	798	86.6	791	85.7
Female	123	13.4	132	14.3
Total	921	100.0	923	100.0

When the PTW rider gender is distributed according to PTW legal category (see Table 7.2) the data shows that more females operate L1 vehicles when compared to L3 vehicles (i.e., 22.4% versus 6.5%). Similarly the data shows that a lower percentage of males ride L1 vehicles when compared with L3 vehicles (i.e., 77.6% versus 86.6%).

Table 7.2: PTW rider gender by PTW legal category

	L1 vehicles		L3 vehicles		Total	
	Frequency	Percent of L1	Frequency	Percent of L3	Frequency	Percent
Male	309	77.6	489	93.5	798	86.6
Female	89	22.4	34	6.5	123	13.4
Total	398	100.0	523	100.0	921	100.0

The distribution of rider age within the accident population and within the exposure population is presented in Figure 7.1. The rider age grouping was developed in order to find meaningful categories of human factor influences based on certain characteristics which are typical for certain age groups in terms of behaviour (e.g., life circumstances, experience, maturity, etc.).

The distribution of rider age within the accident population and within the exposure population is presented in Figure 7.1. The accident and exposure data is quite similar for riders under the age of 17, with 16.8% of all riders being under 17 in the accident population (i.e., 3.1% + 13.7%) and 16.2% of all riders being under 17 in the exposure data (i.e., 3.3% + 12.9%). Young riders under 17 are neither over nor under exposed in the

accident data. Significant differences were noted for riders aged 18 to 21, (chi-square=8.1, $p < .005$) and riders aged 22 to 25 (chi-square=11.7, $p < .001$), indicating that riders in these age categories are over-represented in the accident data. This indicates that these groups are at a greater risk of being involved in an accident and therefore, training and education programs may focus upon these age groups in order to reduce the frequency of their involvement in accidents.

A significant difference between the accident and exposure populations was also found for riders between the ages of 41 and 55 (chi-square=11.2, $p < .001$), indicating that riders in this age category are under-represented in the accident population. The data shown in Figure 7.1 may be found in Annex C Table C.10.

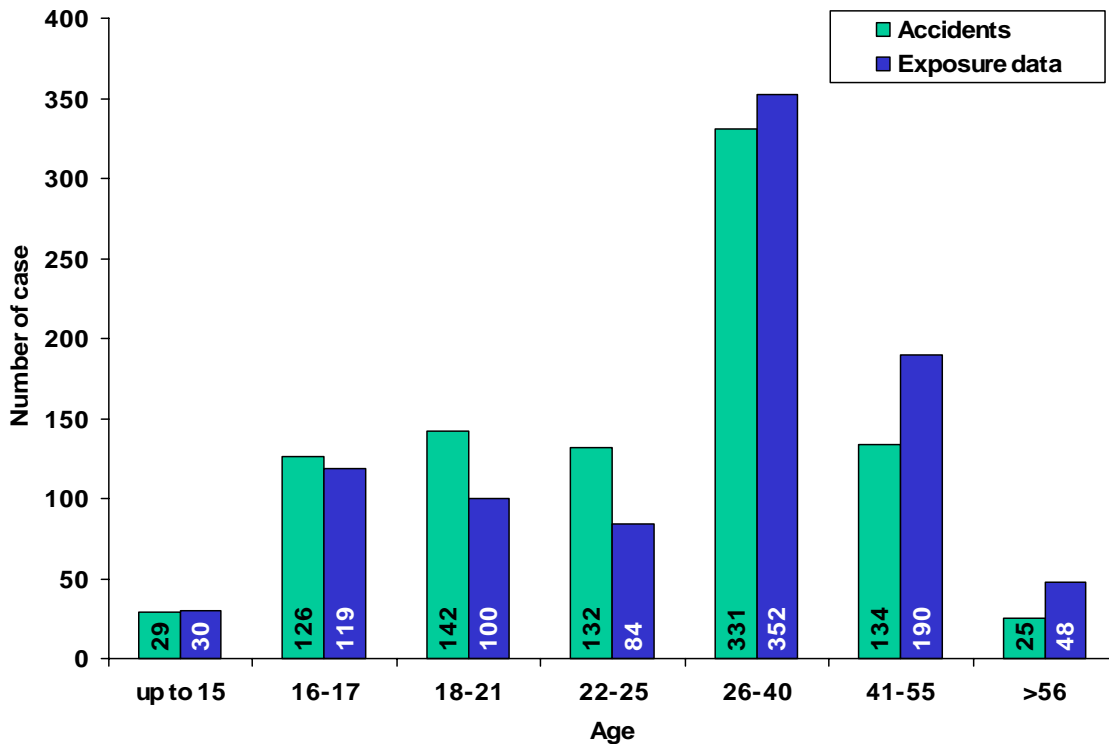

Figure 7.1: PTW rider age

Figure 7.2 shows the distribution of rider ages cross-tabulated with PTW legal category. The data shows that over half of the L1 vehicle riders are under the age of 21 (i.e., 58.7%, 7.0% + 25.6% + 26.1%). In comparison, the majority of L3 vehicle operators are over the age of 26 years (i.e., 70.6%, 50.3%+18.0%+2.3%). The data shown in Figure 7.2 may be found in Annex C Table C.11.

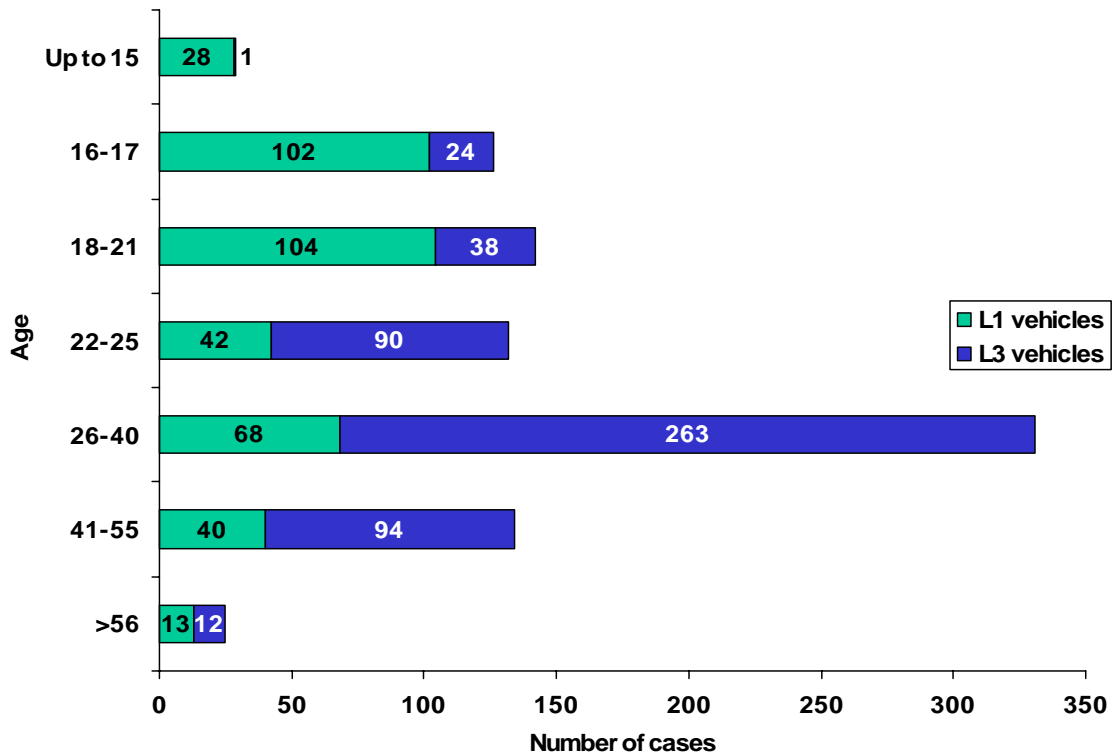

Figure 7.2: PTW rider age by PTW legal category

Figure 7.3 shows the effect that age may have upon the primary accident contributing factors. When cross-tabulated with age, the data indicates that majority of primary accident contributing factors which are related to the PTW rider and OV driver occur in the 26 to 40 year old age group. The data shown in Figure 7.3 may be found in Annex C Table C.12.

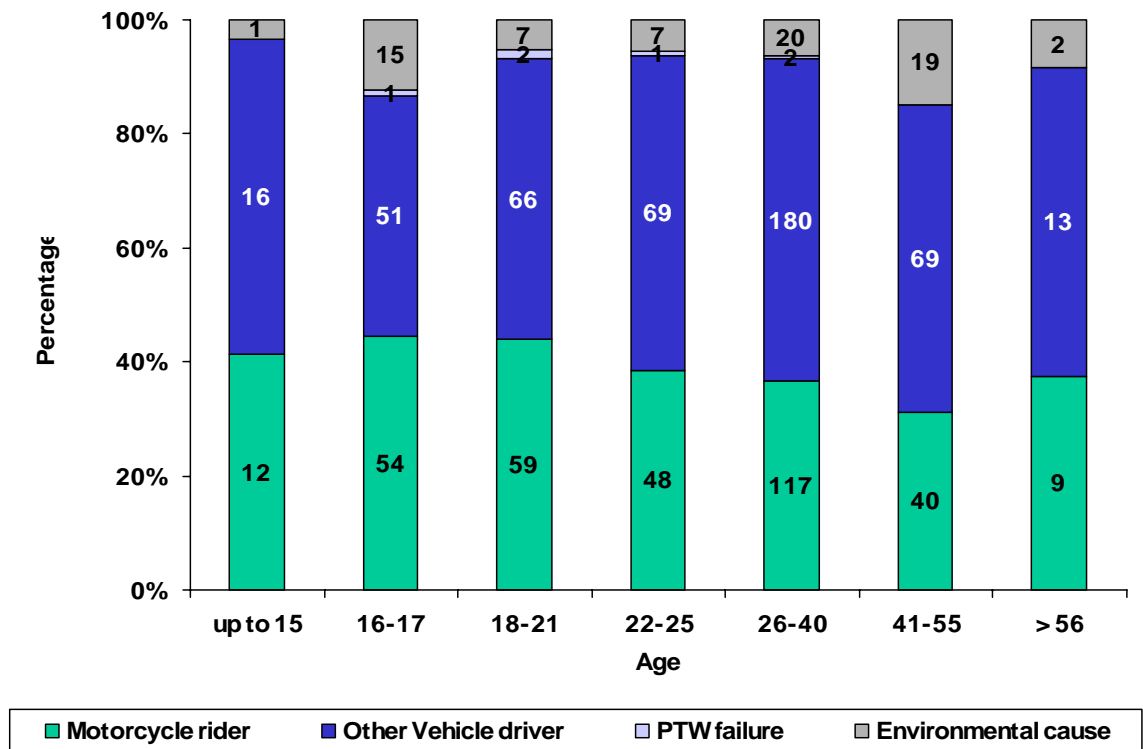

Figure 7.3: Cross-tabulation of PTW rider age by primary accident contributing factor

Figure 7.4 presents the cross-tabulation of the primary accident contributing and the rider age for L1 vehicles. The data shows that younger riders (i.e. under the age of 25) are involved in more accidents where the OV driver was found to be the primary accident cause factor. The data shown in Figure 7.4 may be found in Annex C Table C.13.

In comparison, the data presented in Figure 7.5 (PTW rider age by primary contributing factor for L3 vehicles), shows that riders under 17 were more often found to be the primary accident contributing factor (i.e., 41.7% for riders aged 16 to 17). Older riders (i.e., 26 to 40 years of age) were found to be in more accidents where the OV driver was the primary accident contributing factor. The data shown in Figure 7.5 may be found in Annex C Table C.14.

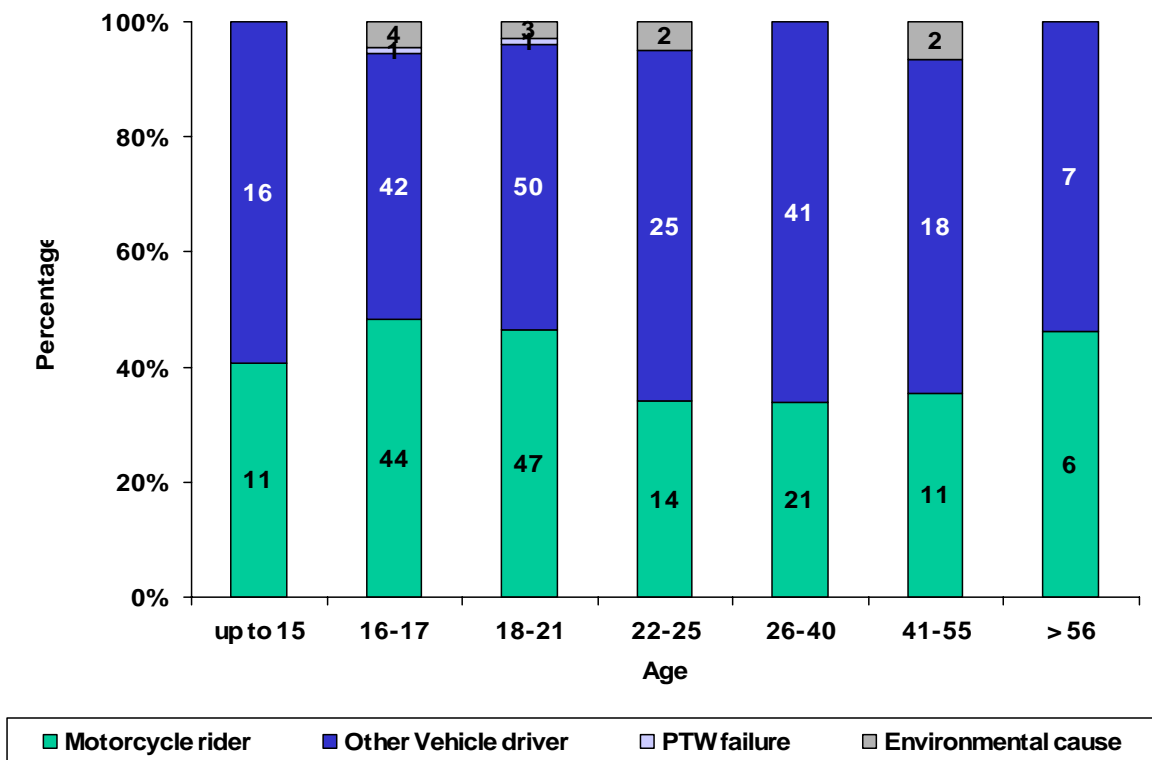

Figure 7.4: PTW rider age by primary accident contributing factor (L1 vehicles)

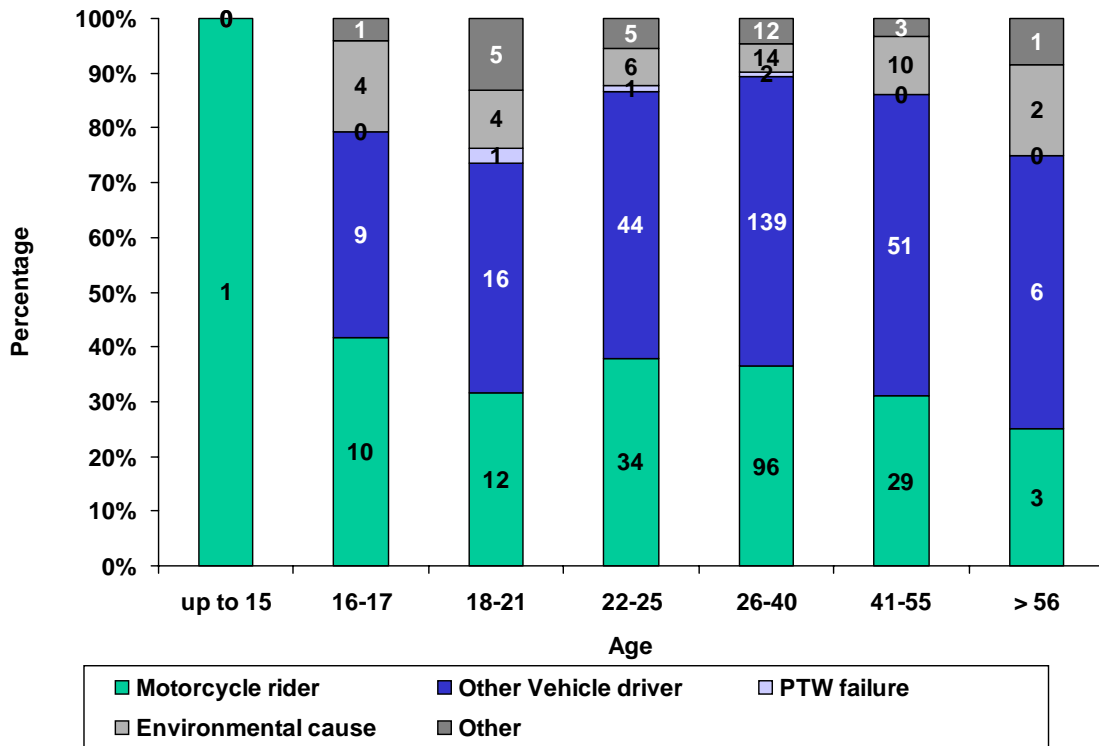

Figure 7.5: PTW rider age by primary accident contributing factor (L3 vehicles)

Figure 7.6 indicates the distribution of PTW travelling speed across the different rider age categories. The travelling speed was determined for each case by a detailed in-depth accident reconstruction. The determined speed does not indicate if the rider was or was not speeding since the allowable speed limit information is not presented here. The speed ranges were developed to better understand variations in a given factor across typical common driving speeds (e.g., dense city traffic speeds up to 30 km/h, normal city traffic speeds of 31 to 50 km/h, city and surrounding area speeds of 51 to 60 km/h and motorway speeds over 60 km/h).

As expected, over half of the accidents involved travelling speeds under 50 km/h when evaluated across all age groups. 56.2% of all riders were travelling at speeds below 50 km/h (i.e., 20.0% + 36.2%). Half of the riders who were travelling at speeds greater than 60 km/h were in the 26 to 40 age group (51.5%). Once again, this does not suggest excessive speed, it merely presents the distribution of travelling speeds across the different age categories. The data shown in Figure 7.6 may be found in Annex C Table C.15.

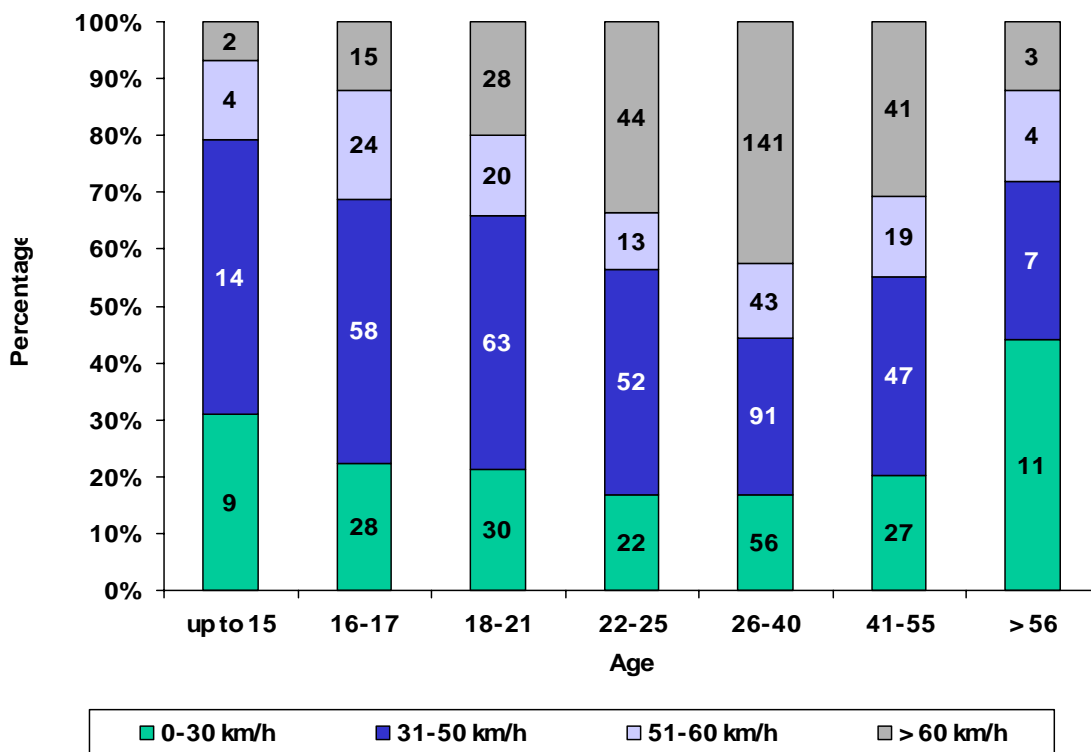

Figure 7.6: PTW travelling speed by PTW rider age

Figure 7.7 indicates the PTW impact speed as calculated from the PTW accident reconstructions performed for each of the 921 accidents investigated during this study. The younger riders (i.e., 21 years and under) were found to be involved in crashes with impact speeds below 50 km/h. Middle aged riders (i.e., 26 yrs to 40 yrs) are involved in accidents at all speeds. This may be a result of the wide variety of different PTWs operated by this age group or it may be the result of some other unknown factor. Older riders (i.e., 41 years and above) were found to be typically involved in accidents that were found to have impact speeds of 50 km/h and below. The data shown in Figure 7.7 may be found in Annex C Table C.16.

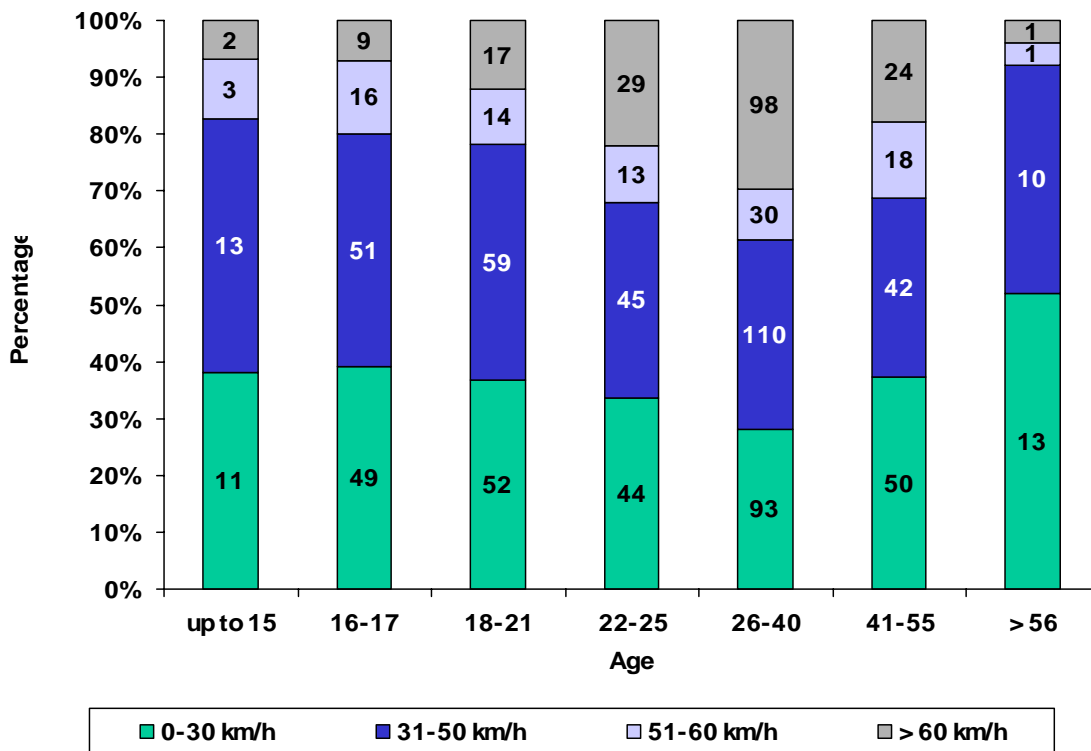

Figure 7.7: PTW impact speed by PTW rider age
(Note: 5 cases unknown)

Table 7.3 shows the distribution of the OV driver age. The majority of drivers were found to be over the age of 26 years. It must be stated that there were several cases of PTW to PTW collision and therefore, the PTW was coded as the OV driver. This would explain the presence of drivers under the age of 18. This data is presented for information only, since no exposure population is available for comparison purposes.

Table 7.3: OV driver age

	Frequency	Percent
up to 15	1	0.1
16-17	11	1.4
18-21	70	9.0
22-25	88	11.3
26-40	275	35.4
41-55	200	25.7
56-98	108	13.9
Unknown	25	3.2
Total	778	100.0

Table 7.4 indicates the distribution of the OV driver licence qualifications. The majority of drivers possessed an automobile licence while 21.0% of the OV drivers also possessed a PTW licence. There were six cases in which the OV driver did not have any licence and there were eight cases in which a licence was not required by the OV driver. This latter case represents cases of PTW to PTW accidents in which the PTW rider was operating a two wheeler that did not require a licence.

Table 7.4: OV driver licence qualification

	Frequency	Percent
None	6	0.8
Automobile licence	519	66.7
PTW licence in addition to automobile licence	163	21.0
Only licence for a vehicle other than PTW and automobile	48	6.2
Not required	8	1.0
Unknown	34	4.3
Total	778	100.0

Figure 7.8 provides a cross-tabulation of the detailed primary accident contributing factor and the OV driver's licence qualification at the time of the accident. The data indicates that those drivers who only have a car licence are likely to commit a perception failure (35.5% of all cases and 50.9% of all drivers with only a car licence). It is interesting to note that OV drivers who also have a PTW licence were much less likely to commit a perception failure, failing to see the PTW in 13.2% of cases where the OV driver perception failure was the primary accident contributing factor. The data shown in Figure 7.8 may be found in Annex C Table C.17.

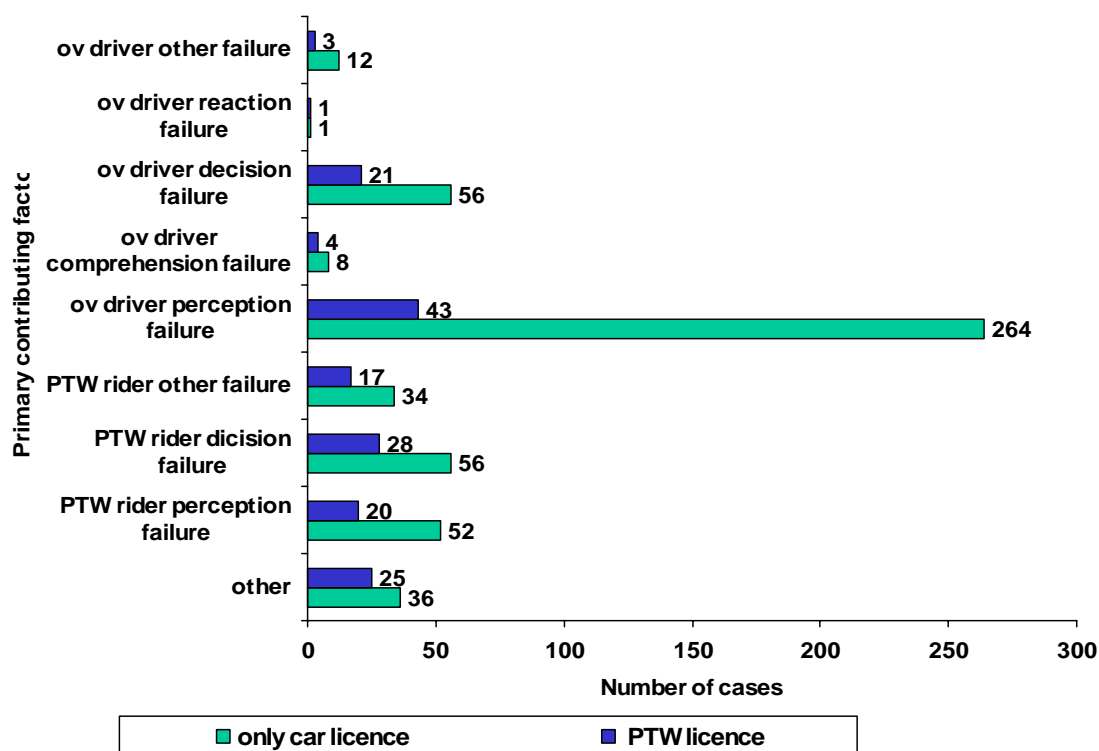

Figure 7.8: Cross-tabulation of primary accident contributing factor by OV driver's licence qualification
 (Note: 33 cases unknown, 6 cases coded as none, 55 cases coded as other/not required)

Table 7.5 provides information regarding the PTW rider licence qualification at the time of the accident and at the time of the petrol station interview. Five percent of riders involved in an accident were found to be without a licence even though one was required and 13.6% (125 of all cases) were found to have a licence, but for vehicles other than a PTW. There were 104 accident cases in which a licence was not required to operate the vehicle involved in the accident.

The data clearly indicates that riders without licences are over-represented in the accident population (chi-square=18.8, $p < .0001$). The data also found that 608 riders who participated in the accident data had a PTW licence, while 697 riders in the petrol station population were found to have a PTW licence. A chi-square test revealed a significant difference between these two groups (chi-square=11.1, $p < .001$), indicating that riders with a PTW licence are under-represented in the accident data.

This suggests that current PTW licensing procedures are adequate with respect to ensuring that PTW riders have the basic skills to operate the PTW in traffic. The under-representation of licenced riders in the MAIDS data suggests that these riders are at less risk of being in an accident when compared to those riders that do not possess a PTW licence.

Table 7.5: PTW licence qualification

	Accident data		Exposure data	
	Frequency	Percent	Frequency	Percent
None, but licence was required	47	5.1	13	1.4
Learner's permit only	4	0.4	1	0.1
PTW licence	608	66.0	697	75.6
Only licence for OVs other than PTW	125	13.6	125	13.5
Not required	104	11.3	86	9.3
Unknown	33	3.6	1	0.1
Total	921	100.0	923	100.0

During the rider interview and accident investigation, the investigator was asked to make the determination if the PTW rider was qualified to operate the accident PTW. This assessment was based upon the PTW category as well as the national regulations regarding PTW operation. Table 7.6 indicates the distribution of the licence qualification of the PTW rider for the vehicle that was in use at the time of the accident or the vehicle that was in use at the time the rider travelled to the petrol station. The data indicates that 78.6% of the PTW riders (724 of all cases) were qualified to operate the accident PTW. Eleven of the riders (1.2% of all cases) were not qualified to operate the accident PTW. This is compared to 36 riders in the exposure data population who were not qualified to operate the PTW. There were 153 cases that are coded as “not applicable” represent those cases where a licence is not required to operate the vehicle.

Table 7.6: Licence qualification for vehicle in use at time of accident or exposure survey

	Accident data		Exposure data	
	Frequency	Percent	Frequency	Percent
Not qualified	11	1.2	36	3.9
Qualified	724	78.6	787	85.3
Not applicable (no licence required)	153	16.6	99	10.7
Unknown	33	3.6	1	0.1
Total	921	100.0	923	100.0

Riders who participated in the MAIDS accident research and riders who participated in the MAIDS petrol station data collection were both asked about their experience on PTWs as well as their experience on the PTW that they were currently riding. Figure 7.9 indicates that approximately one-third of riders in the accident data reported their riding experience to be over 98 months, or over eight years of riding experience on any PTW.

The average amount of riding experience for all riders in the accident data was found to be 53 months with a minimum of 1 month and a maximum of 98 or more months. Since 98 months was the maximum amount of riding experience that could be coded, the true mean amount of riding experience is likely higher than reported. There were 217 cases in which the investigators were not able to determine the riding experience of the PTW rider. This was due in part because the PTW rider would not cooperate with the investigator, but it was also due to the fact that in 100 cases, the PTW rider was killed and this information could not be obtained.

Comparison of the accident data and the exposure data indicates that riders who have less than 6 months experience on any PTW are more likely to be in an accident when compared to the riding population (7.8% of accident cases and 5.2% of petrol station cases).

As expected, riders with a great deal of riding experience on PTWs (i.e. over 98 months) were found to be less likely to be in a PTW accident when compared to the riding population (24.0% of accident cases and 46.7% of petrol station cases). The data shown in Figure 7.9 may be found in Annex C Table C.18.

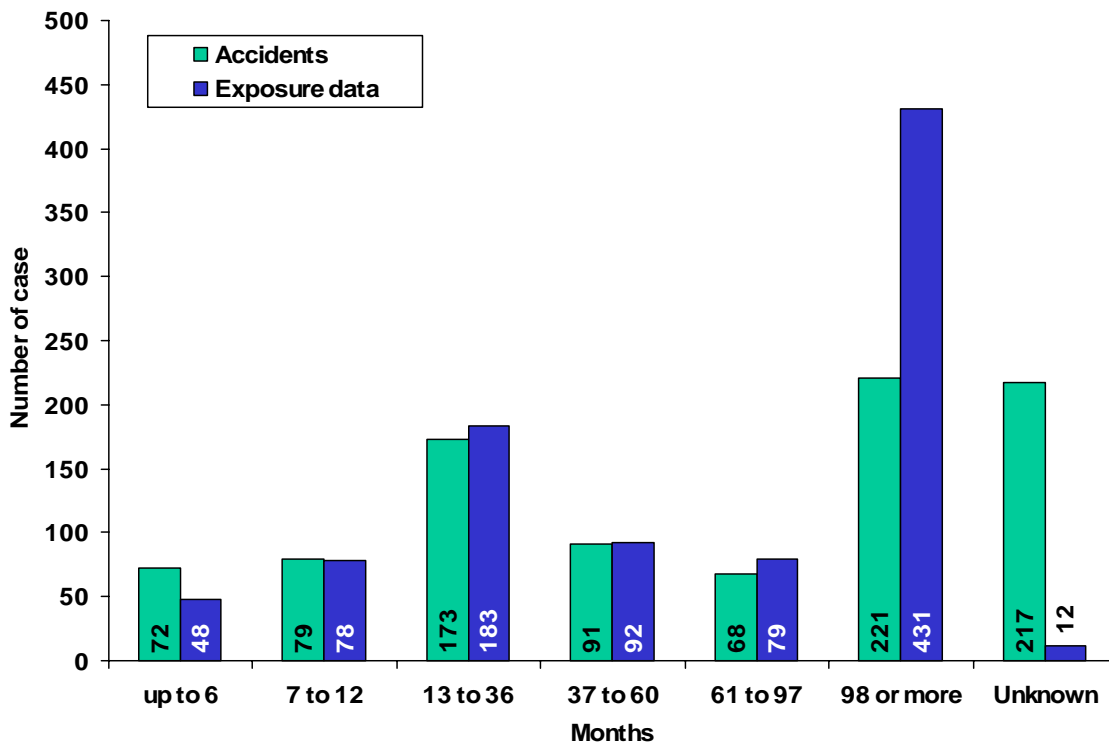

Figure 7.9: Riding experience on any PTW

When asked about their experience on the accident PTW, most riders reported less experience on their PTW. This was not surprising considering that most riders change PTWs over time and very few riders keep the same PTW for long periods of time. Figure 7.10 indicates that most riders had between 0 and 36 months riding experience on the accident PTW. There were 223 cases in which the riding experience on the PTW was unknown. This was again related to the 100 cases in which the PTW rider was killed and information about the rider’s experience could not be obtained.

Comparison between the accident data and the exposure data indicates once again that riders with very little riding experience (i.e., less than 6 months) have a greater risk of being involved in a PTW accident (24.2% of accident involved riders and 22.9% of petrol station riders). The data also clearly indicates that those riders who have a lot of experience riding their PTW are less likely to get involved in an accident (chi-square = 12.38, $p < .001$). The data shown in Figure 7.10 may be found in Annex C Table C.19.

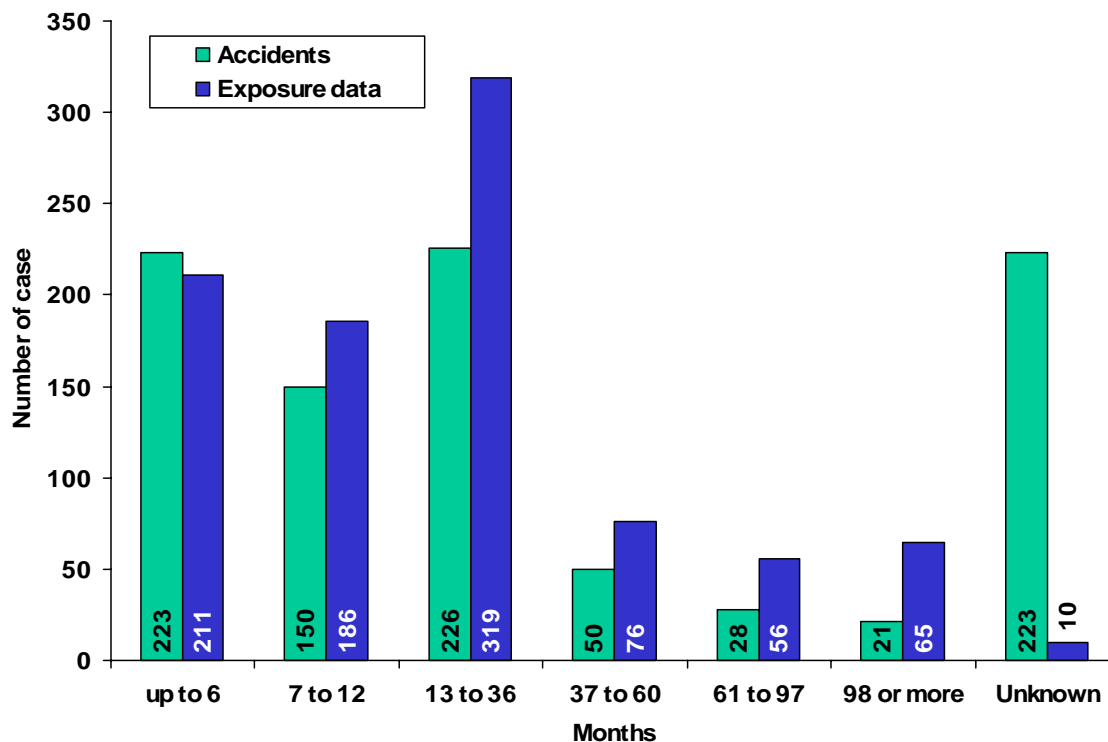

Figure 7.10: Riding experience on vehicle in use at time of accident or exposure survey

Figure 7.11 shows PTW rider experience on the accident PTW, cross-tabulated with PTW legal category. The data that there is very little difference in the amount of riding experience on the accident PTW when L1 and L3 vehicle riders are compared. The data shown in Figure 7.11 may be found in Annex C Table C.20.

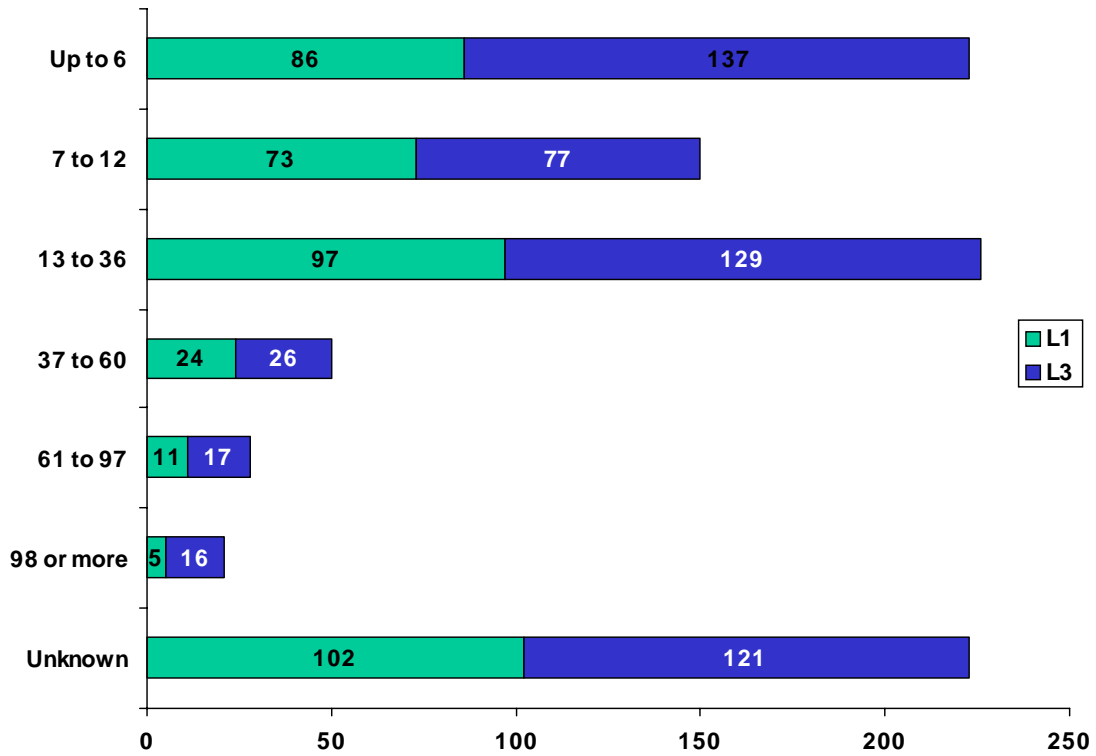

Figure 7.11: Riding experience on accident PTW
(Note: 2 cases unknown)

Figure 7.12 presents the distribution of PTW rider experience on any PTW, cross-tabulated with PTW legal category. The data shows that 40% of the L1 riders have less than 3 years experience on any PTW (i.e., 7.0% + 12.1% + 24.8%). When compared to L3 vehicle riders of the same age, only 28.4% of the riders have less than 3 years experience riding any PTW (i.e., 8.4% + 5.9% + 14.1%). The data shown in Figure 7.12 may be found in Annex C Table C.21.

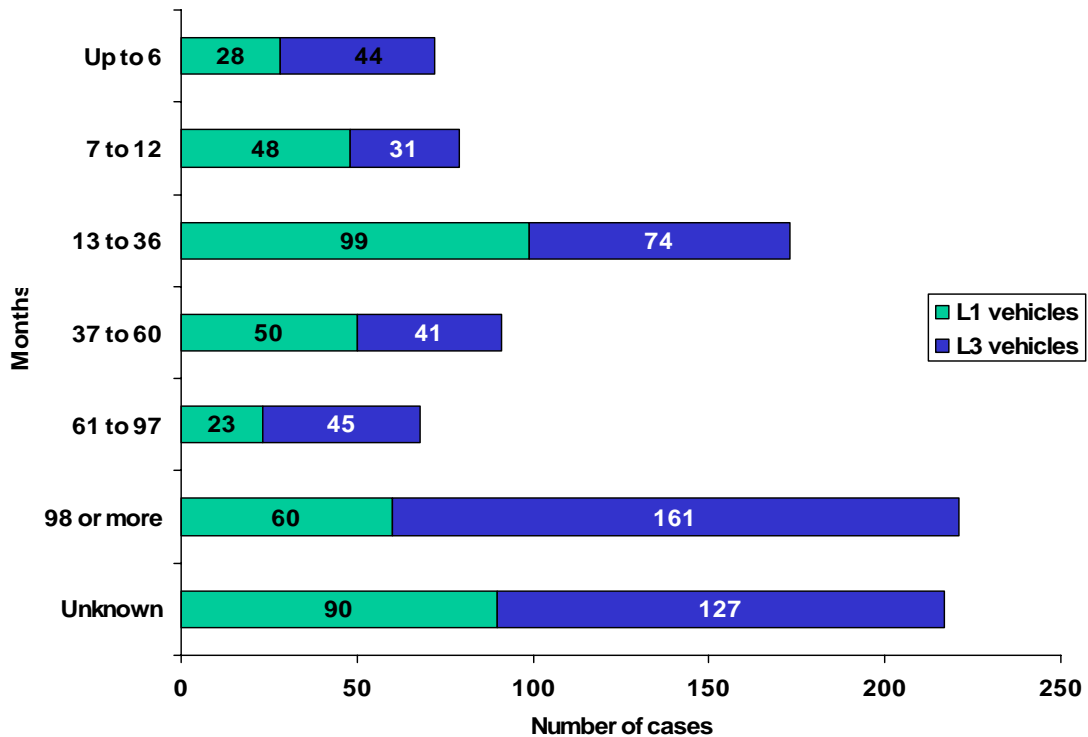

Figure 7.12: PTW rider experience on any PTW

(Note: 2 cases unknown)

Figure 7.13 shows a cross-tabulation of the primary accident contributing factor compared to the riding experience of the PTW rider on any PTW. The data indicates that riders with less experience are more likely to be identified as the primary contributing factor when compared to riders with more experience (47.2% versus 31.7%). For those riders with more than 98 months experience, the OV driver was found to be responsible for the primary accident contributing factor in 57.9% of those cases.

This suggests that riders with less experience are more likely to make decisions or manoeuvres that result in an accident. This may also suggest that riders with less experience are not as skilled at identification of risk or at anticipation of dangerous situations. The data shown in Figure 7.13 may be found in Annex C Table C.22.

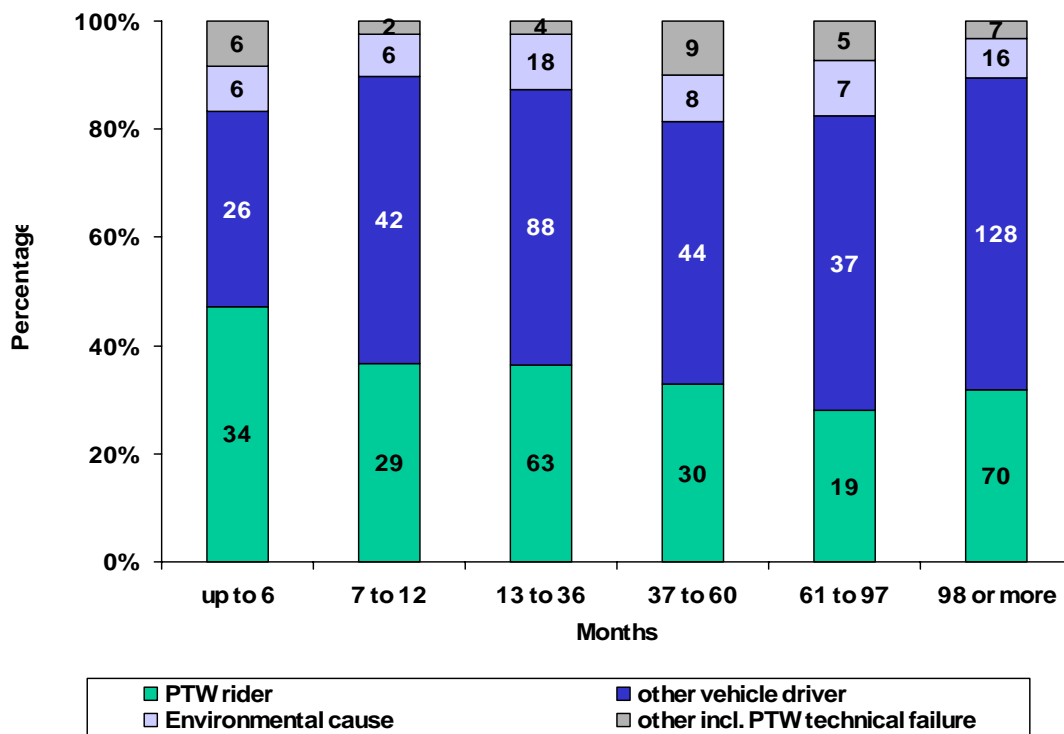

Figure 7.13: Cross-tabulation of primary accident contributing factor by riding experience on any PTW
(Note: 217 cases unknown, 33 cases coded as other)

Table 7.7 presents the reported amount of PTW rider training based upon the rider interview. 47.7% of the riders who were involved in accidents that were collected as part of this study had completed some type of compulsory pre-licence training. Forty percent of riders involved in accidents reported having no type of PTW training. Only four riders were reported as having received some type of additional PTW rider training.

When the accident population and the exposure population are compared, the data indicates that a similar number of riders in both groups have received no PTW training (40.1% of the accident population and 48.4% of the petrol station population). However, it is important to note that the PTW training status for 93 riders was coded as unknown.

The number of riders who had received additional training was small in both populations, thus preventing any type of reliable analysis with regards to the effect of additional training.

Table 7.7: PTW training

	Accident data		Exposure data	
	Frequency	Percent	Frequency	Percent
None	369	40.1	447	48.4
Pre-licence training	439	47.7	461	50.0
Additional training (non-compulsory)	16	1.7	11	1.2
Other	4	0.4	1	0.1
Unknown	93	10.1	3	0.3
Total	921	100.0	923	100.0

When the PTW rider training is presented according to PTW legal category (see Table 7.8), the data shows that 74.9% of L1 vehicle riders have no type of PTW training. Conversely, 77.2% of L3 vehicle riders have some type of pre-licence training.

Table 7.8: Cross-tabulation of PTW training by PTW legal category

	L1 vehicles		L3 vehicles		Total	
	Frequency	Percent of L1	Frequency	Percent of L3	Frequency	Percent
None	298	74.9	71	13.6	369	40.1
Pre-licence training	35	8.8	404	77.2	439	47.7
Additional training	8	2.0	8	1.5	16	1.7
Other	0.0	0.0	4	0.8	4	0.4
Unknown	57	14.3	36	6.9	93	10.1
Total	398	100.0	523	100.0	921	100.0

Figure 7.14 presents a cross-tabulation of PTW rider training and collision avoidance manoeuvre. The data indicates that 47.2% of those riders without any type of training failed to attempt a collision avoidance manoeuvre. Similarly, the data indicates that 33.2% of those riders who had compulsory training also failed to attempt a collision avoidance manoeuvre. These results are difficult to interpret since there were many cases in which there was insufficient time available for the PTW rider to perform any kind of collision avoidance.

The number of riders with additional training must be considered to be too small to make observations. The data shown in Figure 7.14 may be found in Annex C Table C.23

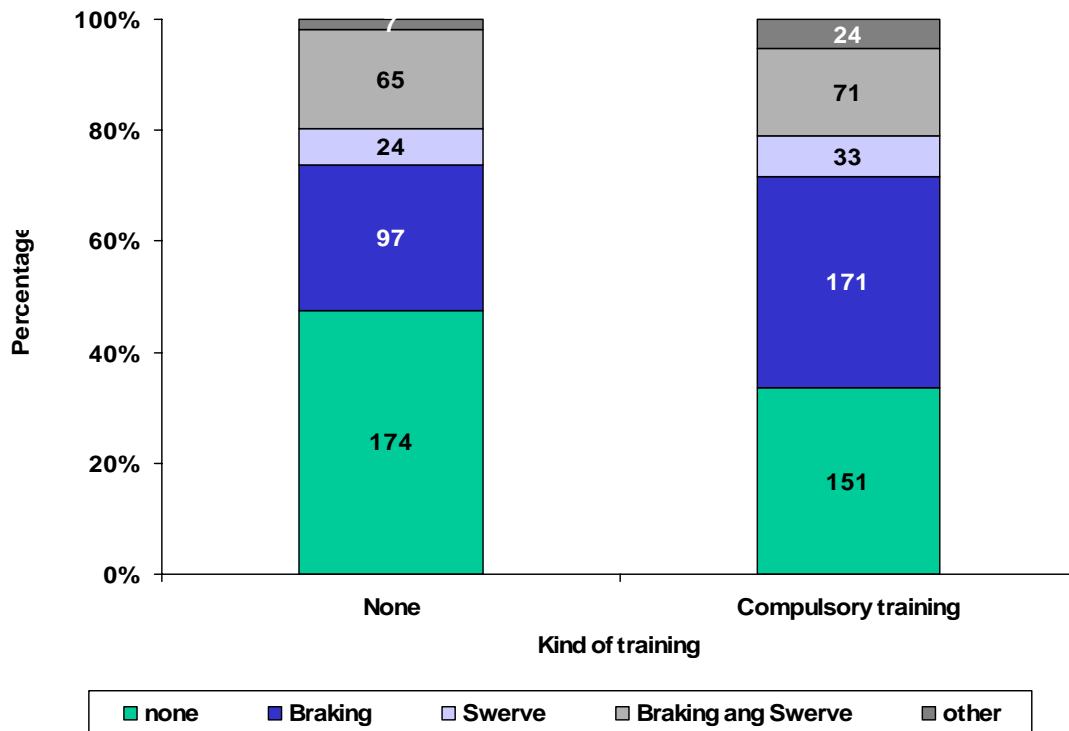

Figure 7.14: PTW collision avoidance manoeuvre by PTW training
 (Note: 97 cases unknown, 4 cases coded as additional training)

The presence of alcohol or drugs was considered to be an important accident contributing factor that required special attention during each MAIDS case investigation. It is well known that alcohol and/or drug impairment can reduce the PTW rider's ability to properly operate the PTW. A total of 36 riders were found to have been under the influence of alcohol at the time of the accident. This information was obtained either from the police agencies that investigated the accident or from the on-scene interview of the PTW rider and OV driver. If during the interview the investigator suspected alcohol or drug usage (e.g., smell of breath, mental state, etc.), the investigator was instructed to code the presence of alcohol or drugs even if the police agency did not report any such presence.

The distribution of alcohol and drug use for both vehicle operators is presented in Tables 7.9 and 7.10. Alcohol use by the PTW rider was reported in 36 of the 921 investigated cases (3.9% of all cases) and drug use by the PTW rider was reported in five cases (0.5% of all cases). There were two reported cases in which the PTW rider had taken both alcohol and drugs. There were twenty five cases in which the usage of alcohol and drugs was unknown.

Alcohol and drug usage for the OV driver was found to be less than the alcohol and drug usage for the PTW rider. Only 18 cases of alcohol use by the OV driver was reported (2.3% of all cases) and only 4 cases of drug use (0.5% of all cases). There were a higher percentage of unknown cases for the OV driver and this was most likely related to a lack of cooperation from the OV driver (i.e., a refusal to provide interview to the MAIDS investigator).

During the petrol station interviews, a total of 14 riders were found to be under the influence of alcohol. A chi-square test was found to be significant at $p < .002$ with an odds

ratio of 2.7. This suggests that alcohol involved riders are over-represented in the MAIDS accident population and the unadjusted odds of being in an accident when the rider is under the influence of alcohol are 2.7 times greater than when they are not under the influence of alcohol.

Table 7.9: Alcohol/ drug use by PTW rider

	Accident data		Exposure data	
	Frequency	Percent	Frequency	Percent
None	853	92.6	902	97.8
Alcohol	36	3.9	14	1.5
Drug	5	0.5	2	0.2
Alcohol+drug	2	0.2	2	0.2
Unknown	25	2.7	3	0.3
Total	921	100.0	923	100.0

Note: drug use is defined as the use of illegal, non-prescription drugs (e.g., cocaine).

Table 7.10: Alcohol/drug use by the OV driver

	Frequency	Percent
None	712	91.5
Alcohol	18	2.3
Drug	4	0.5
Unknown	44	5.7
Total	778	100.0

Following the complete reconstruction of the PTW accident, the investigators were asked to consider whether or not they felt that the PTW rider or the OV driver had exhibited a skill deficiency that contributed to the cause of the accident. This deficiency could represent a deficiency in turning, signalling or even collision avoidance manoeuvres.

Table 7.11 indicates that in 82.7% of all MAIDS cases, there was no skill deficiency noted for the PTW rider. In 10.0% of the cases (n=92), there was a skill deficiency noted that was also a contributing factor in the accident. This indicates the importance of PTW rider training; however, no exposure data is available to determine whether or not this factor is over or under-represented in the accident data.

Table 7.11: Skills deficiency (PTW rider)

	Frequency	Percent
Skills deficiency present as a contributing factor	92	10.0
Skills deficiency present, but not a contributing factor	46	5.0
Not applicable, no evidence of skills deficiency	762	82.7
Unknown	21	2.3
Total	921	100.0

Table 7.12 shows that less than one percent of all OV drivers were considered to have a skill deficiency that contributed to the accident (0.8%).

Table 7.12: Skills deficiency (OV driver)

	Frequency	Percent
Skills deficiency present as a contributing factor	6	0.8
Skills deficiency present, but not a contributing factor	21	2.7
Not applicable, no OV or no evidence of skills deficiency	724	93.0
Unknown	27	3.5
Total	778	100.0

When skill deficiency is cross-tabulated with PTW rider experience (see Figure 7.15), the data indicates a higher number of inexperienced riders (i.e., up to 6 months experience) were found to have a skill deficiency that contributed to the accident when compared to riders that had over 98 months of experience on a PTW (29.0% versus 6.4%). The data shown in Figure 7.15 may be found in Annex C Table C.24.

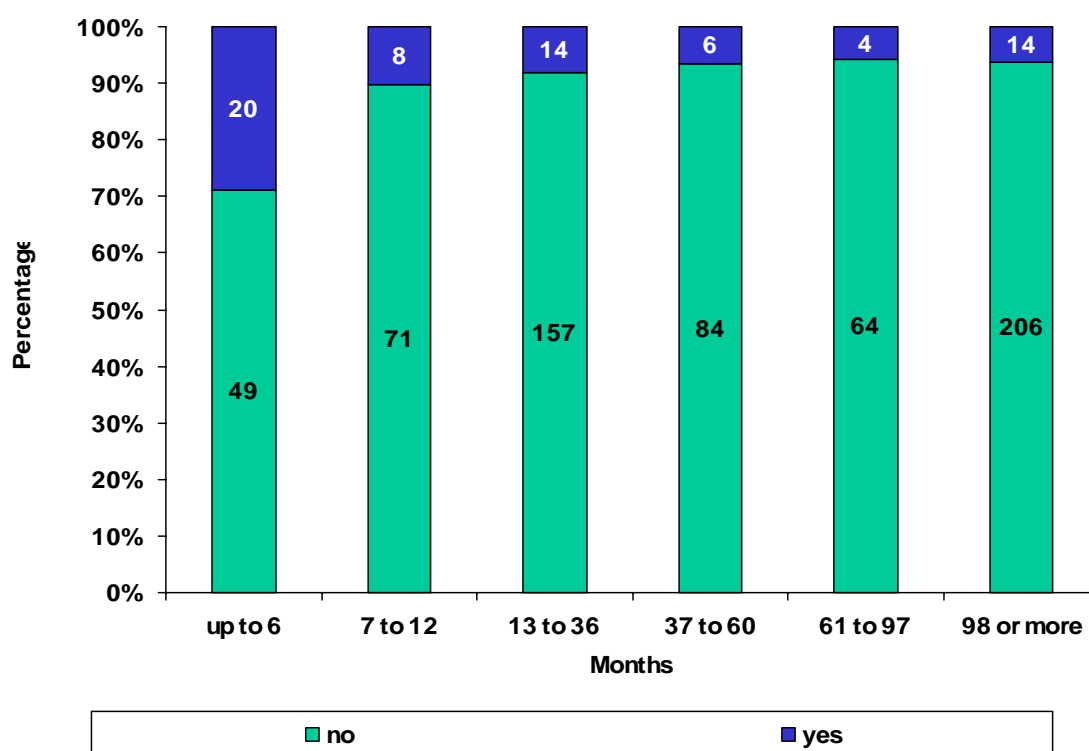

Figure 7.15: Cross-tabulation of PTW rider experience by identification of skill deficiency as a contributing factor

(Note: 26 cases unknown riding experience)

Findings on human factors

- Neither males nor females were over- or under-represented in the accident population.
- Riders under 17 were neither under- nor over-represented in the accident data. Riders between 18-21 and 22-25 were over-represented, while riders between 41 and 55 were under-represented in the accident population. This suggests that riders between the ages of 41 and 55 have less risk of being in an accident when compared to the general riding population.
- 58.7 % of the L1 operators were under 21, while 88.1% of the L3 operators were over 21.
- Riders under 21 were the primary accident contributing factor 42% of the time, while riders over 21 were the primary contributing factor less than 37% of the time.

- Riders of all ages were most often involved in impact speeds of 50 km/h or less (70%).
- 77% of OV drivers were over the age of 26, almost all were licenced and 21% also had a PTW licence.
- OV operators who also held a PTW licence were less likely to commit perception failures than OV operators who did not have a PTW licence (26.4% versus 50.9%).
- Improperly licenced or unlicenced riders were over-represented in the accidents, suggesting that these riders have greater risk of being involved in an accident when compared to qualified riders.
- 24.2% of accidents involved riders with less than six months experience.
- In general riders with more experience are less likely to be the primary contributory factor of an accident.
- 29% of riders with less than 6 months experience had a skills deficiency and this percentage went down to 6.4% for riders with over 98 months of experience.
- Low rates of alcohol or other drug impairment were found among all riders and OV drivers. However, when the PTW rider was under influence of alcohol, he was 2.7 times more likely to be involved in an accident.

8.0 Powered two wheelers in a mixed traffic environment

PTWs represent an important sector of the road traffic population. Their relatively small size makes them a viable solution for congested European roadways. However, when compared to other forms of transportation, it is commonly accepted that PTWs represent a vulnerable road user from the perspective of protection and visibility. Specific variables were collected for each MAIDS case to address some of these issues and they are presented in the following section.

Visibility

PTW riders rely heavily upon the ability to see obstructions and traffic hazards well in advance so that appropriate collision avoidance manoeuvres may be made. Similarly, OV drivers must be able to see PTWs in the roadway environment in order to avoid accidents.

Tables 8.1 and 8.2 describe the presence of any visibility limitations along the pre-crash path for both the PTW and the OV. Visibility was defined as the ability to see oncoming traffic in a clear and consistent manner. It does not include view obstructions, which are evaluated separately.

Weather conditions were found to limit the visibility for the PTW riders in 29 cases (3.1% of all cases). Visibility limitations for the OV driver were reported in 25 cases (3.2% of all cases). A visibility limitation was considered to be any situation in which the PTW rider or the OV driver was unable to see the surrounding traffic or was unable to be seen by the surrounding traffic due to an environmental condition (e.g., heavy rain).

It is important to note that this data indicates only whether the investigators coded a visibility limitation. This data does not indicate that the visibility limitation contributed to the causation of the accident. Table 4.24 located in the accident causation section of this report indicates that weather contributed to accident causation in 7.5% of all cases (n=67); therefore, it may be assumed that many of those cases involved some type of visibility limitation.

Table 8.1: Visibility limitation (PTW rider)

	Frequency	Percent
None	888	96.5
Weather condition	29	3.1
Other	2	0.2
Unknown	2	0.2
Total	921	100.0

Table 8.2: Visibility limitation (OV driver)

	Frequency	Percent
None	734	94.3
Weather condition	25	3.2
Other	5	0.7
Unknown	14	1.8
Total	778	100.0

A significant advantage of travelling to the accident scene following the accident was that the investigating team could make direct observations of view obstructions along the pre-crash path of all vehicles. This allowed each team to code the presence of both stationary and mobile view obstructions along the pre-crash path of the vehicle. A stationary view obstruction was defined as any object obstructed the PTW rider or OV drivers' field of vision and was immobile or fixed at the time of the accident. This included buildings, trees, signs and parked cars. Mobile view obstructions were defined as any object that would obstruct the PTW or OV driver's field of vision and was mobile at the time of the collision. This would include large trucks, buses, construction equipment as well as passenger cars in transit.

Table 8.3 indicates that stationary view obstructions (e.g., signs, buildings, etc.) were reported in 18.1% of all cases. Vegetation and stationary or parked vehicles were the most frequently reported stationary view obstructions for the PTW rider, representing 6.7% and 5.4% of all cases respectively.

Table 8.4 indicates that a mobile view obstruction was reported in 9.5% of accidents (i.e., the sum of all mobile view obstructions in Table 8.4). Automobiles were found to be the most frequently reported mobile view obstruction being reported in 6.0% of all cases. The reported frequency of light trucks and vans was about 2% and trucks and buses as mobile view obstructions were found to be about 1%. It is interesting to note that in two cases, people or pedestrians were reported as a view obstruction.

Table 8.3: Stationary view obstructions for PTW rider

	Frequency	Percent
None	753	81.9
Buildings	19	2.1
Signs	4	0.4
Vegetation, trees, walls	62	6.7
Hill	4	0.4
Blind curve	14	1.5
Stationary or parked vehicles	50	5.4
Barricades	3	0.3
Other	11	1.2
Unknown	1	0.1
Total	921	100

Table 8.4: Mobile view obstructions for PTW rider

	Frequency	Percent
None	826	89.7
Automobiles	55	6.0
Light trucks and vans	16	1.7
Trucks and busses	11	1.2
People, pedestrians	2	0.2
Other	4	0.4
Unknown	7	0.8
Total	921	100.0

Since the OV might have travelled on a different pre-crash path to the PTW rider, it was important to record the presence of any stationary view obstructions for the OV driver. Table 8.5 indicates that vegetation, trees and parked vehicles also represented the most frequently reported stationary view obstructions for the OV driver (6.7% for each). Buildings were also reported as stationary view obstructions in 20 cases (2.6% of all cases).

Table 8.5: Stationary view obstructions for OV driver

	Frequency	Percent
None	607	78.0
Buildings	20	2.6
Signs	8	1.0
Vegetation, trees, walls	52	6.7
Hill	4	0.5
Blind curve	9	1.2
Stationary or parked vehicles	52	6.7
Barricades	4	0.5
Other	10	1.3
Unknown	12	1.5
Total	778	100.0

Table 8.6 indicates the distribution of mobile view obstructions for the OV driver. A mobile view obstruction was reported in 88 cases (11.6% of all cases) and the most frequently reported mobile view obstruction was an automobile (6.8%). Light trucks and vans were the next most frequently reported mobile view obstruction (2.2%), followed by trucks and buses.

Table 8.6: Mobile view obstructions for OV driver

	Frequency	Percent
None	669	86.0
Automobiles	53	6.8
Light trucks and vans	17	2.2
Trucks and busses	12	1.5
Other	6	0.8
Unknown	21	2.7
Total	778	100.0

The information presented above suggests that environmental factors contribute to overall PTW accident causation. Tables 4.7 and 4.8 in the accident causation section demonstrate that visual obstructions contribute to the accident causation. Neglect of the visual obstruction, either mobile or stationary was reported for 18.5% of PTW riders and 22.6% of OV drivers.

The data provided in the MAIDS database also indicates that there are many PTW accidents that are due to a lack of perception by the OV driver and by the PTW rider (see Table 4.1).

The traffic environment in which PTW accidents occur must be well defined in order to be able to validate measures under real circumstances. For each MAIDS accident, the traffic density at the time of the accident was coded based upon the investigators assessment of the traffic density, including information from witness statements. Table 8.7 indicates that traffic in the PTW direction of travel was light in 56.1% of collected cases, moderate in 29.9% of cases and heavy in 12.9% of cases. For the OV, the traffic density was found to be almost identical to that of the PTW (see Table 8.8).

Table 8.7: Traffic density at time of accident (PTW)

	Frequency	Percent
Light	517	56.1
Moderate	275	29.9
Heavy	119	12.9
Unknown	10	1.1
Total	921	100.0

Table 8.8: Traffic density at time of accident (OV)

	Frequency	Percent
Light	423	54.4
Moderate	231	29.7
Heavy	109	14.0
Unknown	15	1.9
Total	778	100.0

These findings indicate that PTW accidents occur more frequently in light traffic conditions, suggesting that other road users may not be expecting the presence of a PTW. Additional data regarding road use would be helpful to clarify this situation.

Lighting and conspicuity

The ability of the PTW rider to see and be seen is a critical element of PTW safety. As mentioned above, the largest number of PTW accidents is due to a perception failure on the part of the OV driver or the PTW rider. The vehicle operator failed to see a PTW or OV. This may be due to the lighting conditions at the time of the accident or the conspicuity of one vehicle relative to the environment or its background. For this research, conspicuity was defined as the ability of the PTW, the PTW rider or the OV to draw attention and be noticed in the traffic environment. Specific variables within the MAIDS database were collected to try to evaluate these factors.

Table 8.9 shows that nearly three-quarters of the collected accidents (672 cases, 73.0%) took place during daylight hours, and 18.8% of the accidents (173 cases, 34 + 139) took place at night in areas where there was street lighting. 34 cases (3.7%) were reported in which the accident took place at night in an area without street lighting.

Table 8.9: Illumination at time of accident

	Frequency	Percent
Daylight	672	73.0
Dusk/dawn	76	8.2
Night without street lighting	34	3.7
Night with street lighting	139	15.1
Total	921	100.0

The use of the PTW headlamp has been recognised as an aid to conspicuity. During the MAIDS accident investigations, the research teams were asked to determine if the headlamp had been in use at the time of the accident. This was done initially by the interview with the PTW rider and then confirmed using a detailed inspection of the headlamp assembly (e.g., identification of headlamp filament deformation).

Table 8.10 indicates that for 24.2% of the accidents collected, the headlamp was not in use at the time of the accident. In many cases, a switched off headlamp was likely to have been a contributing factor to accident causation. It was not possible to make a determination of whether or not the lack of headlamp usage had increased or decreased the risk of being in a PTW accident because the exposure data collection procedure involved an evaluation of PTWs that were refuelling and stopped at the time of the evaluation, and thus not riding.

Table 8.10 also shows the reported frequency of headlamp across the L1 and L3 PTW categories. The data shows that 41.2% of all L1 vehicles were not using the headlamp(s) at the time of the accident. This is quite different in comparison to the L3 vehicle data which shows that 85.3% of the L3 vehicle riders were using their headlamp(s) at the time of the accident.

Table 8.10: Headlamp(s) in use at time of accident?

	L1 vehicles		L3 vehicles		Total	
	Frequency	Percent of L1	Frequency	Percent of L3	Frequency	Percent
No	164	41.2	59	11.3	223	24.2
Yes	193	48.5	446	85.3	639	69.4
Unknown	41	10.3	18	3.4	59	6.4
Total	398	100.0	523	100.0	921	100.0

During the accident investigation at the scene, investigators were required to obtain photographs along the pre-crash path of both vehicles. This provided visual information on the relationship between the PTW or OV (if applicable), and the visible background at the time of the precipitating event. The investigators were then required to code the relationship between this visual background and the ability of the PTW rider/OV driver to identify the oncoming vehicle. If the visual background had provided a contrasting background relative to the vehicle, then it was considered to have had a positive effect on conspicuity (i.e., the visual background made the vehicle more noticeable). If however the background had provided little contrast relative to the PTW or OV, then the visual

background was coded as having had a negative effect upon conspicuity. If the investigators were not able to make a clear decision on the relationship of the visual background and the vehicle, then the code 'no contribution' was reported.

Table 8.11 presents the effect of the visual background of the OV along the PTW rider's line of sight. The data shown indicates that the visual background made no contribution to the conspicuity of the OV in 55.5% of all cases (n=511). The background had a positive effect on conspicuity in 5.5% of all cases (n=51) and a negative effect on conspicuity also in 5.6% of all cases (n=52). There were 297 cases in which there was either no OV or there was no visual background available for analysis. An example of this latter case would be when the OV is in a dip in the roadway and not visible to the PTW at the time of the precipitating event.

Table 8.11: Visual background of OV along PTW rider's line-of-sight at time of precipitating event (PTW)

	Frequency	Percent
No contribution	511	55.5
Positive effect on conspicuity	51	5.5
Negative effect on conspicuity	52	5.6
Not applicable	297	32.3
Unknown	10	1.1
Total	921	100.0

Table 8.12 presents the contribution of the visual background with respect to the PTW conspicuity at the time of the precipitating event. In the case of multiple vehicle collisions, only the first OV's line of sight was considered. The data indicates that the visual background had no effect upon conspicuity in 54.1% of all MAIDS cases (n=421) and in 58 cases the visual background made the PTW more conspicuous (i.e., positive effect). In 112 cases (14.4%), the visual background made the PTW less conspicuous (i.e., negative effect), which is over two times greater than the number reported for the OV. There were eighteen cases reported in which the effect of the visual background was not known.

Table 8.12: Visual background of PTW along the OV driver's line-of-sight at time of precipitating event

	Frequency	Percent
No contribution	421	54.1
Positive effect on conspicuity	58	7.5
Negative effect on conspicuity	112	14.4
Not applicable	169	21.7
Unknown	18	2.3
Total	778	100.0

The clothing worn by the PTW rider was photographed and evaluated for each MAIDS case. A determination was made by the investigator as to whether or not this clothing contributed to the conspicuity of the PTW and the PTW riders. This evaluation was purely subjective on the part of the investigator. Table 8.13 indicates that in 65.3% of all cases, the clothing made no contribution to the conspicuity of the rider or the PTW. There were very few cases found in which the bright clothing of the PTW rider enhanced the PTW's overall conspicuity (46 cases). There were more cases in which the use of dark clothing decreased the conspicuity of the rider and the PTW (120 cases).

Table 8.13: Contribution of PTW rider clothing to conspicuity

	Frequency	Percent
No apparent contribution of upper or lower torso garment	601	65.3
Bright colour upper and lower torso garment enhanced conspicuity	25	2.7
Bright upper torso garment enhanced conspicuity	21	2.3
Dull/dark upper and lower torso garment decreased conspicuity	103	11.2
Dull or dark upper torso garment decreased conspicuity	17	1.8
Dark upper and lower torso garment increased conspicuity	1	0.1
No apparel worn or no OV involvement	78	8.5
Unknown	75	8.1
Total	921	100.0

Findings on powered two wheelers in a mixed traffic environment

Visibility and view obstructions

- Visibility was limited by an environmental condition for both the PTW operator and the OV operator in 3% of the cases.
- Stationary view obstructions, including vegetation and parked vehicles, were recorded for 18.0% of the PTW riders and 20.5% of the OV operators. At the time of the accident, there were mobile view obstructions, cars, trucks and buses, for 9.5% of the PTW riders and 11.6% of the OV drivers.
- Almost 90% all PTW accidents occur in light to moderate traffic conditions.
- The headlamp was in use for 69.4% of the accident PTWs.
- The effect of the background on PTW conspicuity was positive in 7.5% and negative in 14.4% of multi-vehicle cases.
- The use of dark PTW rider clothing decreased conspicuity in 13.0% of all accidents.

9.0 Rider protection

The previous sections have provided information regarding the collision configurations and the contributing factors related to PTW accident causation. This section focuses upon rider protection and provides a detailed description of the injuries sustained by the PTW riders and passengers as well as the clothing that was used at the time of the accident and the effect of that clothing.

As shown previously, the majority of PTW accidents involves collisions with OVs, predominantly passenger cars (60.0%, see Table 3.4). Therefore, any efforts to reduce PTW injury severity must first examine what is struck by the PTW, and in most cases, the PTW rider. In this way, potential strategies may be developed to reduce or mitigate PTW rider injuries when caused by vehicle contact. As part of the detailed accident reconstruction, investigators were required to identify the first collision contact between the PTW and the OV. By detailed reconstruction and vehicle inspection, the investigator had to identify which part of the PTW had come into contact with the collision object (i.e., the OV, the roadway or some other object).

The distribution of these PTW collision contact codes is presented in Figure 9.1. The data indicates that the first collision contact was most frequently the front centre of the PTW. The next most frequently reported collision contacts were at the right front and left front of the PTW, suggesting that it might have been at a slight angle immediately prior to the collision. There were six cases reported in which there was no direct contact to the PTW, meaning that only the PTW rider was struck, probably due to the fact that the PTW rider separated from the PTW during the pre-crash phase of the accident. The data shown in Figure 9.1 may be found in Annex C Table C.25.

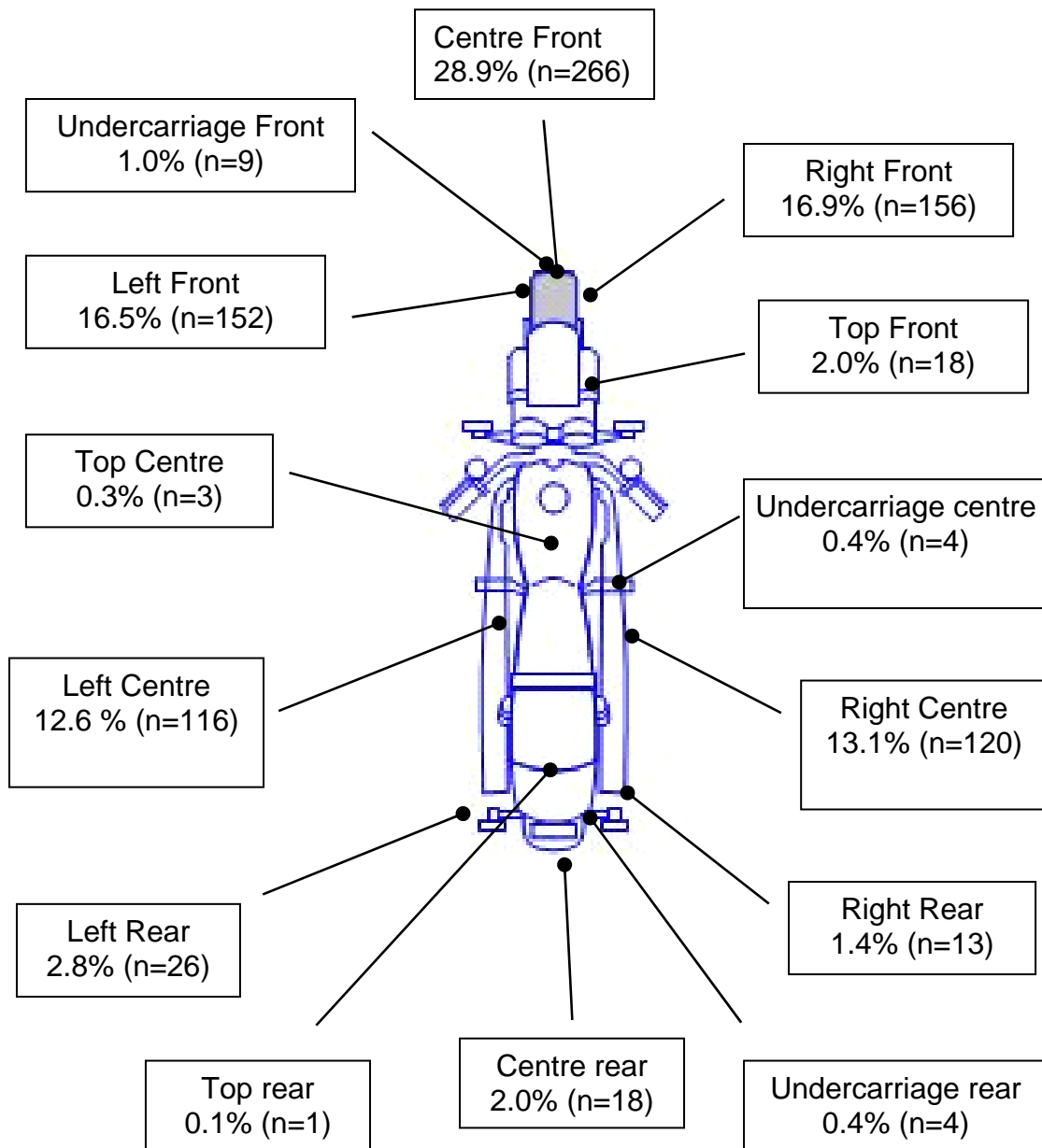

Figure 9.1: PTW first collision contact code

The distribution of the OV first collision contact codes is presented in Figure 9.2. The most frequently struck portion of the OV was the left side (21.9% of all cases), followed by the right side (18.2% of all cases). Collisions to the front of the OV were reported in 37.1% of all cases. Note that a PTW was the OV in 8.2% of the multi-vehicle collisions (n=65), and that it also tended to have a first collision contact on its front or left side. The data shown in Figure 9.2 may be found in Annex C Table C.26.

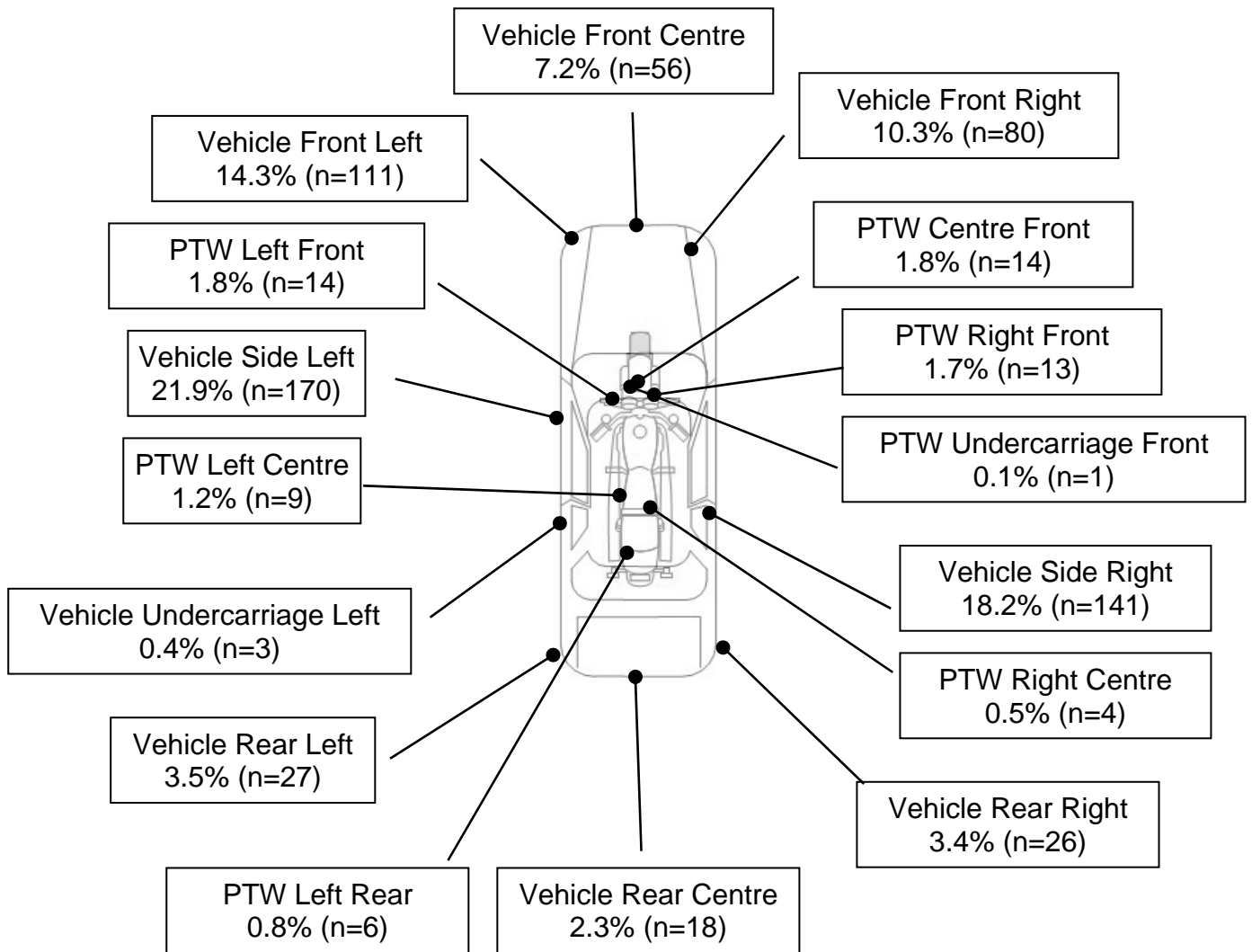

Figure 9.2: OV first collision contact code

PTW Rider injury

The in-depth investigation of PTW accidents within the MAIDS database required that a complete documentation of all rider and passenger injuries be performed for each case. This required the investigator to contact either the rider or the medical authorities directly (with the approval and consent of the rider) or contact the rider and obtain consent from the rider to get the necessary injury information. Where permitted, photographs were taken of all rider and passenger injuries and included in the hard copy data file.

The data form allowed for the collection of eighty-one separate injuries for both the rider and any passengers. Injuries were categorized according to one of nine separate body regions and all injuries were coded using the 1998 AIS coding scheme (AAAM, 1990). In addition to the AIS code, a specific code was introduced to indicate the side of the injury as well as the specific standardised anatomical location of the injury (e.g., proximal, distal, medial or lateral).

Since PTW riders were often hospitalized (see Table 9.1), the research team monitored the trauma status of each rider and passenger. This included regular contact

with the medical authorities as well as the rider or passenger in order to note whether or not the rider had been released from hospital or whether or not the rider had died.

Table 9.1 provides a summary of the PTW trauma status for all MAIDS cases. The data indicates that three cases involved riders who were not injured as a result of the accident. While these cases do not qualify as an acceptable case according to the sampling requirements of the Common Methodology, it was decided they would be useful to add to the database for accident causation information.

Twenty-two riders only received first aid treatment at the scene of the accident. A total of 785 riders were treated in hospital and then released. One hundred PTW riders died as a result of injuries sustained in a PTW accident. There were seven cases in which the trauma status of the PTW rider was not determined.

Table 9.1: PTW rider trauma status

	Frequency	Percent
No trauma	3	0.3
First aid only	22	2.4
Disabled	4	0.4
Hospital treatment up to 8 days	522	56.8
Hospital treatment more than 8 days	121	13.1
Hospital treatment, unknown number of days	142	15.4
Fatal (within 30 days)	97	10.5
Fatal, unknown number of days	2	0.2
Deceased after 30 days	1	0.1
Unknown	7	0.8
Total	921	100.0

Note: There were cases with multiple fatalities

A total of 3644 injuries were recorded for 921 PTW riders and 79 PTW passengers. It is important to note that the total number of injuries for a given body region may exceed the number of riders (i.e., 921) because there were many cases where riders or passengers received multiple injuries to the same body region.

When both PTW rider and passenger injuries are grouped, the data indicates that lower extremity injuries were most frequently reported (1159 injuries, or 31.8% of all injuries), followed by upper extremity injuries (871 injuries, or 23.9% of all injuries). A total of 683 head injuries and 38 neck injuries were reported.

The distribution of rider injuries is presented in Figure 9.3 and a detailed description of all PTW rider injuries is presented in Annex C, Table C.27.

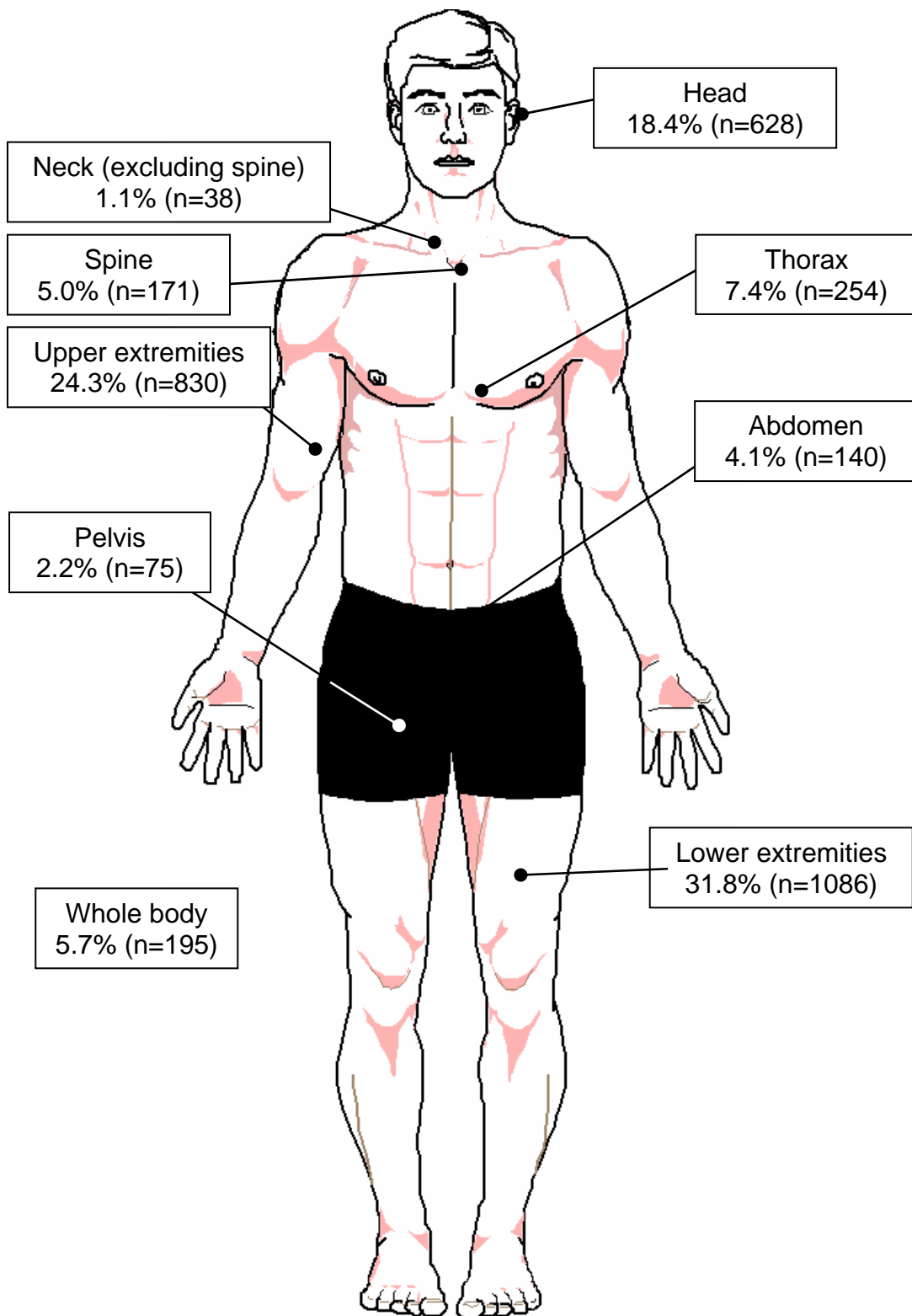

Figure 9.3: Summary of the distribution of PTW rider injuries greater than AIS=1 (number in parenthesis indicates total number of reported injuries for that region, total number of injuries to the PTW rider = 3417)

As mentioned previously, all injuries were coded according to the six different levels of the AIS coding system, ranging from minor injuries (AIS =1) to severe (AIS =4), critical (AIS = 5) and maximum injuries (AIS = 6). Maximum injuries are usually, but not inevitably fatal. For each case and each body region it was possible to identify the most severe AIS injury for that body region. This injury was considered to be the MAIS for that particular region.

Figure 9.4 presents the distribution of the PTW rider MAIS across the nine different body regions that were used to categorize the injuries. The data indicates that the majority of head and neck MAIS injuries were minor or moderate (i.e., AIS 1 or 2). Half of the thoracic MAIS injuries were AIS 1 level injuries (e.g., laceration or abrasion) while ninety-percent of the upper extremity injuries were reported as being minor (e.g., laceration) or moderate (e.g., simple fracture).

The reported spine MAIS injuries were mostly minor or moderate; however, there were fifteen reported cases of severe, critical and maximum spinal injuries. These injuries would include severe spinal fracture or spinal cord lesions and trauma. The maximum spinal cord injuries involved cord transection or complete and massive disruption of the spinal cord.

The majority of lower extremity MAIS injuries consisted of lacerations or abrasions of minor injury severity. This represented 53.5% of all reported lower extremity MAIS injuries. One hundred and fifty eight moderate level MAIS injuries (23.2% of all reported lower extremity injuries) and one hundred and forty-three serious lower extremity MAIS injuries (21.0% of all reported lower extremity MAIS injuries) were reported. The data shown in Figure 9.4 may be found in Annex C Table C.28.

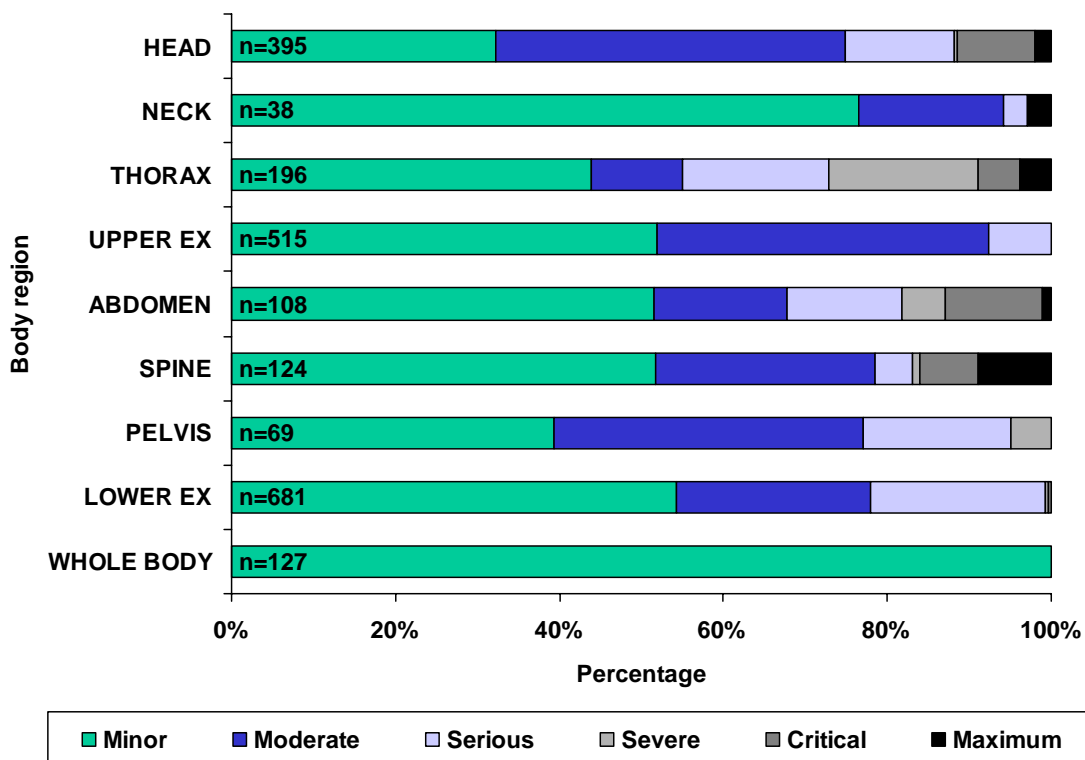

Figure 9.4: Cross-tabulation of rider MAIS by body region

As part of the in-depth investigation of each case, all investigators had to identify two unique collision contact codes for each reported injury. Injuries could be classified as being either due to direct trauma (e.g., direct contact with a surface or object) or indirect trauma (e.g., as a result of remote contact with a surface or object or by another part of the body). Over 500 unique environment, vehicle or helmet collision contact codes were available for each injury.

As shown in Figure 9.4, maximum AIS (MAIS) codes were generated for each case and for each body region. This MAIS information was then compared to the collision contact codes that were identified as being related to the MAIS injury. The following tables illustrate the distribution of these MAIS values relative to the different collision contact codes. For reporting purposes, the contact codes previously mentioned were divided into five major categories (i.e., OV, PTW, road/roadside, helmet and animal or pedestrian). Cases with no reported injury to a given body region (and therefore no MAIS value) were removed from this analysis.

Figure 9.5 shows the distribution of rider head MAIS by collision contact codes. The data indicates that the OV and the roadside are the collision contact codes for over 85.7% of all reported head injuries (i.e., 229 cases out of 267). The OV was identified as the collision contact code in three reported maximum head injuries. It is important to note that the data presented in this table includes cases where a helmet was not worn and cases in which the helmet came off the riders head during the accident. The data shown in Figure 9.5 may be found in Annex C Table C.29.

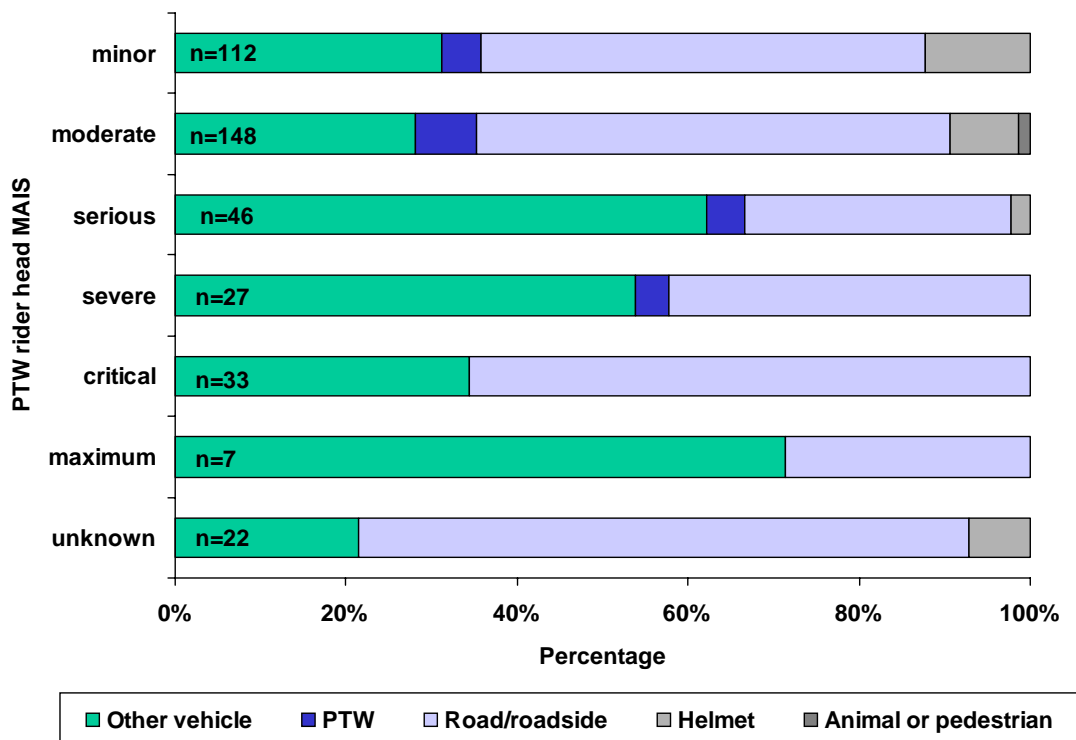

Figure 9.5: Distribution of rider head MAIS by collision contact code
 (Note: There were 526 cases in which the rider did not sustain a head injury)

Figure 9.6 shows the distribution of rider neck MAIS by collision contact code. As expected, the OV and the road/roadside were the dominant collision contact codes for neck injury. There were no reported cases in which the helmet was identified as the

contact code for a serious or maximum neck injury. Most neck injuries were minor, typically abrasions, lacerations or contusions. Neck pain was also reported as a minor injury. The data shown in Figure 9.6 may be found in Annex C Table C.30.

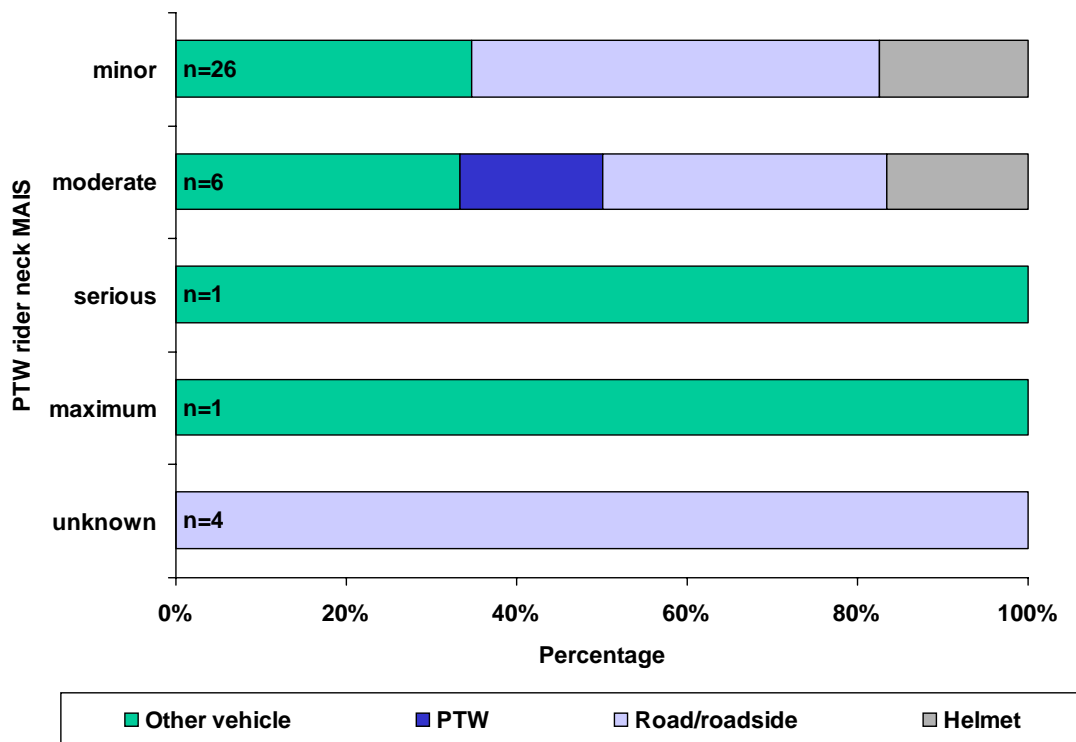

Figure 9.6: Distribution of rider neck MAIS by collision contact code
 (Note: There were 883 cases in which the rider did not sustain a neck injury)

Figure 9.7 presents the distribution of the PTW rider upper extremity MAIS by the collision contact code. Minor upper extremity injuries were most often the result of contact with the road/roadside (i.e., 75.3% of all reported MAIS minor injuries) while the majority of serious upper extremity injuries were the result of a collision contact with the OV (i.e., 55.2% of all reported MAIS serious upper extremity injuries). The data shown in Figure 9.7 may be found in Annex C Table C.31.

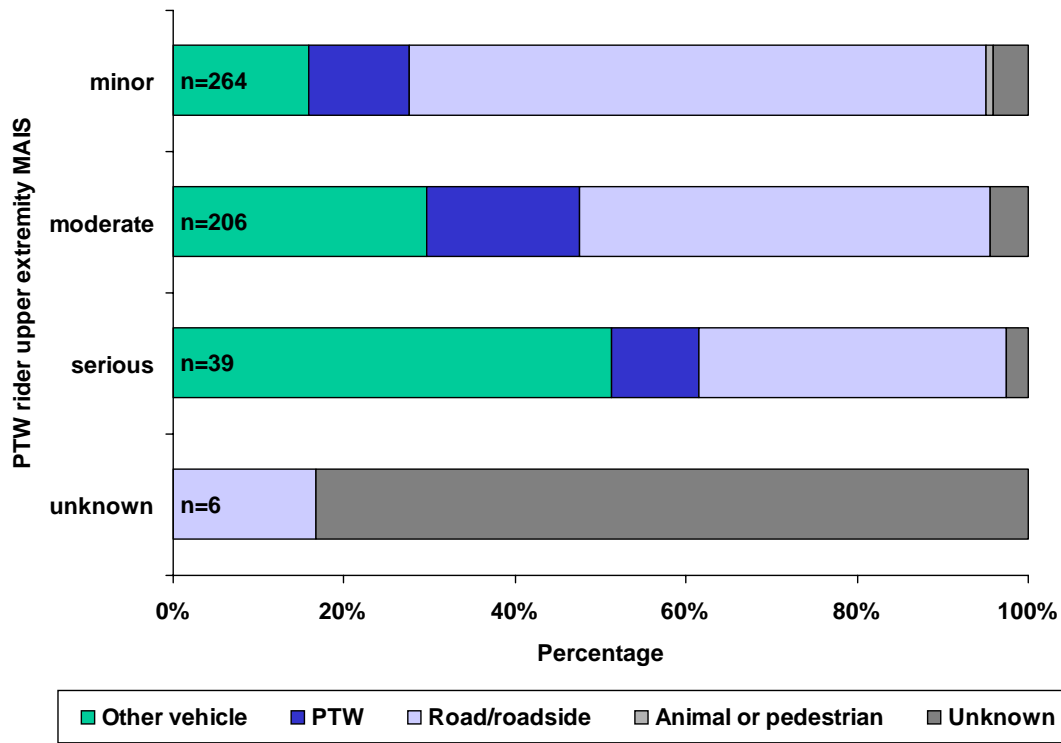

Figure 9.7: Distribution of rider upper extremity MAIS by collision contact code
 (Note: There were 406 cases in which the rider did not sustain an upper extremity injury)

Figure 9.8 presents the distribution of the thoracic MAIS by collision contact code. Minor thoracic injuries were mostly due to roadside contact while more serious, critical and maximum injuries could be due to contact with the road/roadside, the OV or the PTW. The data shown in Figure 9.8 may be found in Annex C Table C.32.

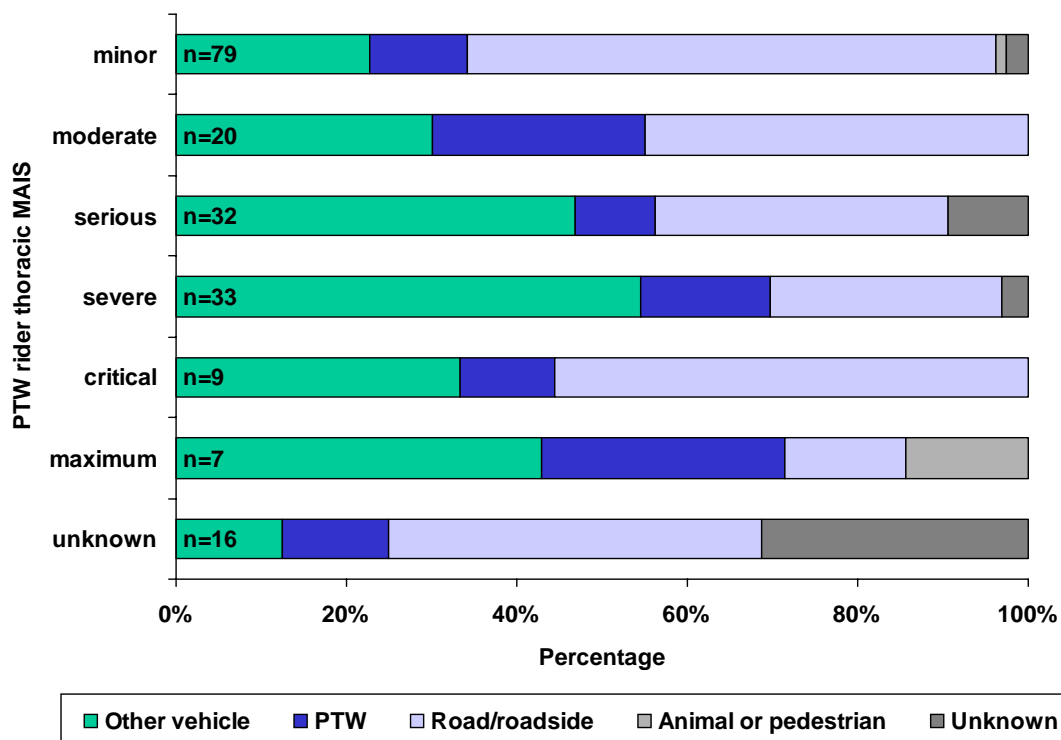

Figure 9.8: Distribution of rider thoracic MAIS by collision contact code
 (Note: There were 725 cases in which the rider did not sustain a thoracic injury)

Figure 9.9 shows the distribution of the rider abdominal MAIS across the three major collision contact code groups. The data appears to be almost equally distributed, with only the road/roadside collision contact code occurring with only greater frequency. The only reported maximum MAIS abdominal injury was due to a collision with an OV. The data shown in Figure 9.9 may be found in Annex C Table C.33.

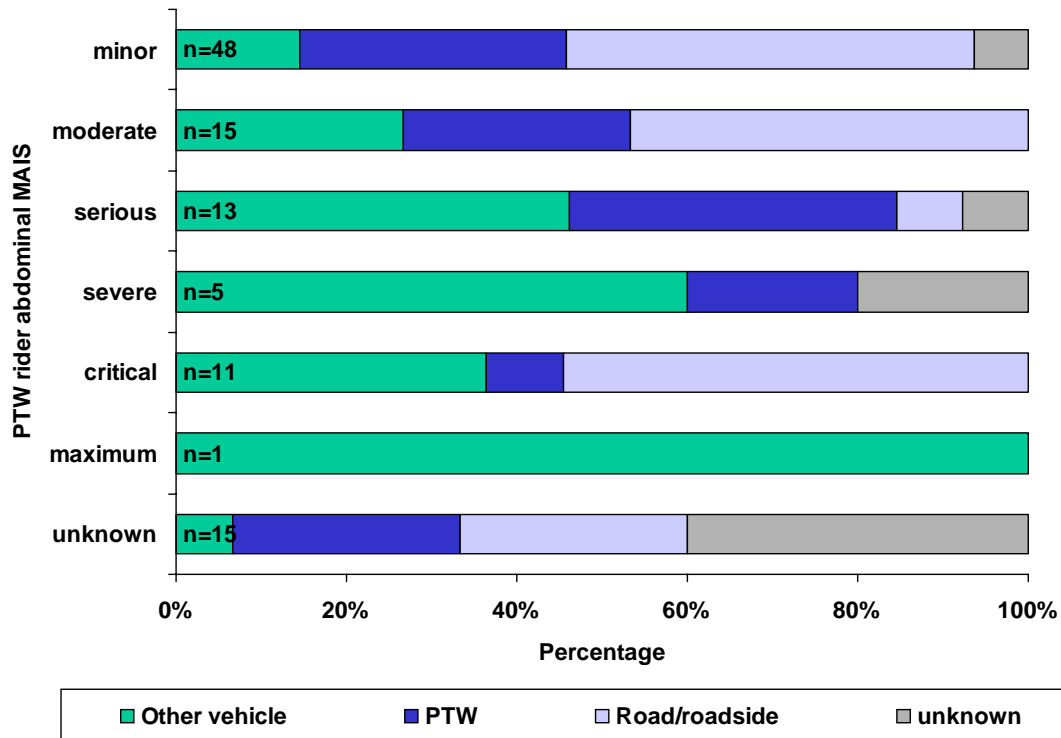

Figure 9.9: Distribution of rider abdominal MAIS by collision contact code
 (Note: There were 813 cases in which the rider did not sustain an abdominal injury)

The frequency of pelvic rider injuries was found to be quite low in the MAIDS database (e.g., 2.1% as reported in Table 9.4). Figure 9.10 indicates that most pelvic MAIS injuries were minor and most were due to road or roadside contact. A PTW component was identified as the collision contact code in 17 cases (34% of all MAIS pelvic injuries). The data shown in Figure 9.10 may be found in Annex C Table C.34.

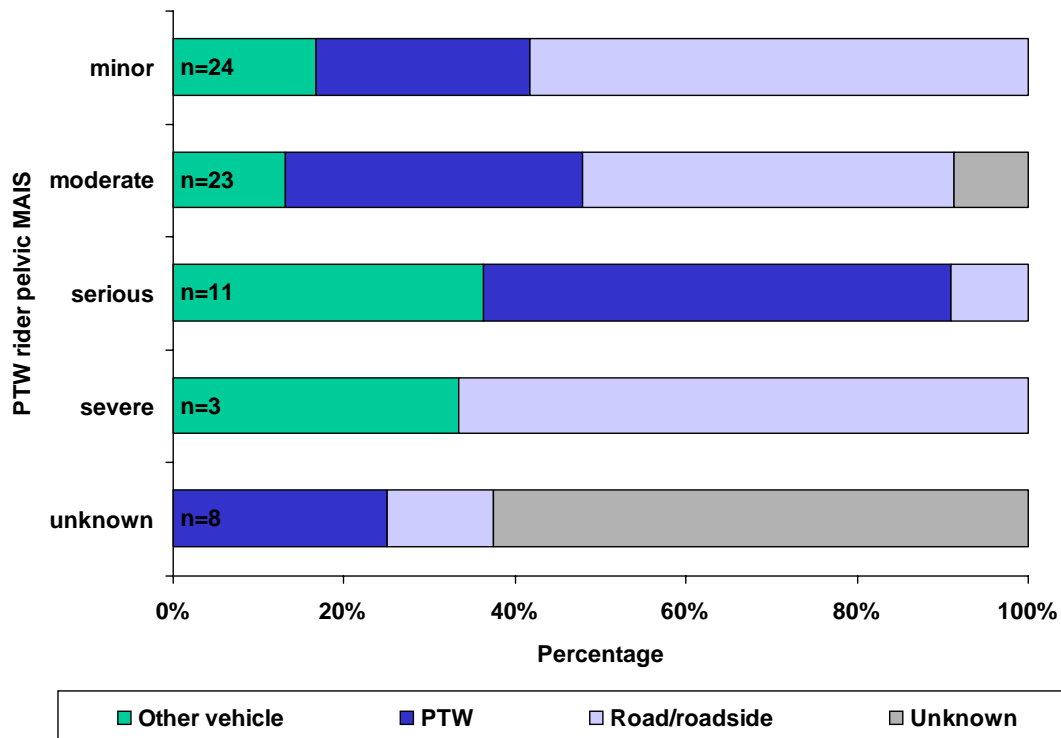

Figure 9.10: Distribution of rider pelvic MAIS by collision contact code
 (Note: There were 852 cases in which the rider did not sustain a pelvic injury)

Figure 9.11 shows that 97% of the rider spine MAIS were due to contact with either the OV (30% of MAIS spinal injuries) or with road/roadside elements (66.7% of MAIS spinal injuries). Twelve of the thirteen critical and maximum spinal injuries were due to contact with the OV and the roadway/roadside. The helmet was identified as a collision contact code for one severe spinal injury, representing 1.7% of all MAIS spinal injuries and 0.1% of all cases investigated during this study.

Over two-thirds of PTW rider MAIS spine injuries were reported as being minor or moderate in severity (71% of all reported MAIS spine injuries). Most of these minor and moderate injuries were the result of roadway or roadside contact (i.e., 31 of 43 reported minor and moderate spine MAIS injuries). The data shown in Figure 9.11 may be found in Annex C Table C.35.

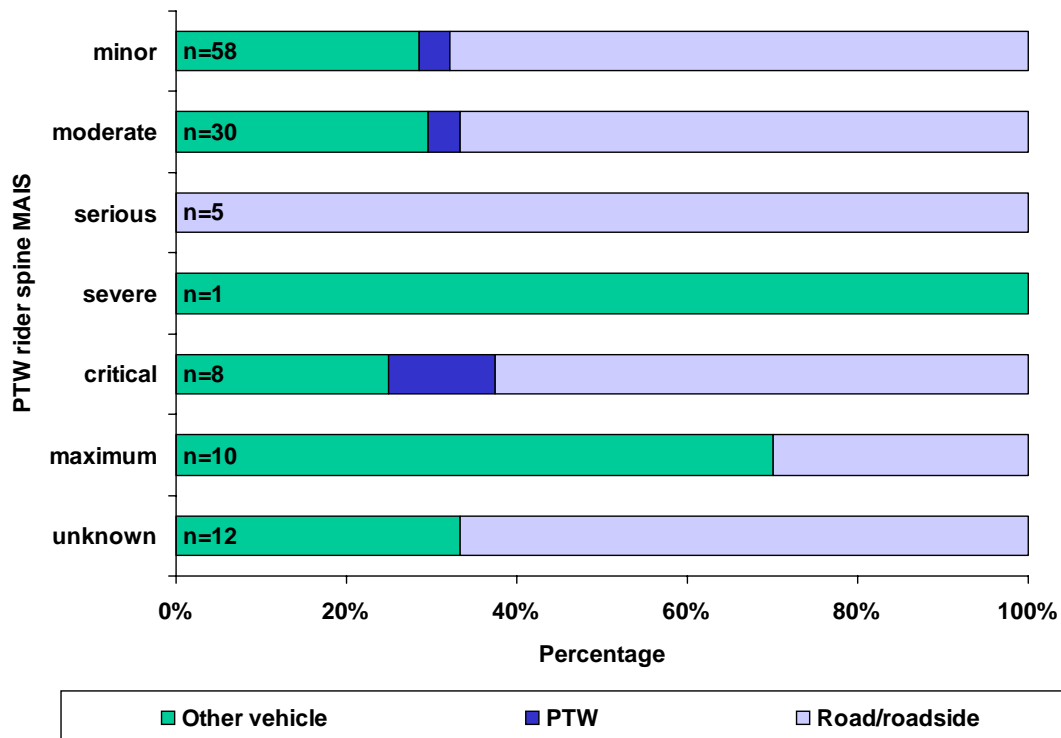

Figure 9.11: Distribution of rider spine MAIS by collision contact code
 (Note: There were 797 cases in which the rider did not sustain a spinal injury)

Figure 9.12 indicates that 58.4% of all lower extremity MAIS injuries sustained by riders were minor (e.g., lacerations or abrasions) and that two-thirds of these minor injuries were due to road/roadside contact, most likely following the initial collision with the OV (if an OV was present).

Serious lower extremity MAIS injuries were due mainly to OV collision contact (e.g., 40.6% of all serious MAIS cases) as well as PTW contact (33.8% of all serious MAIS cases). The data shown in Figure 9.12 may be found in Annex C Table C.36.

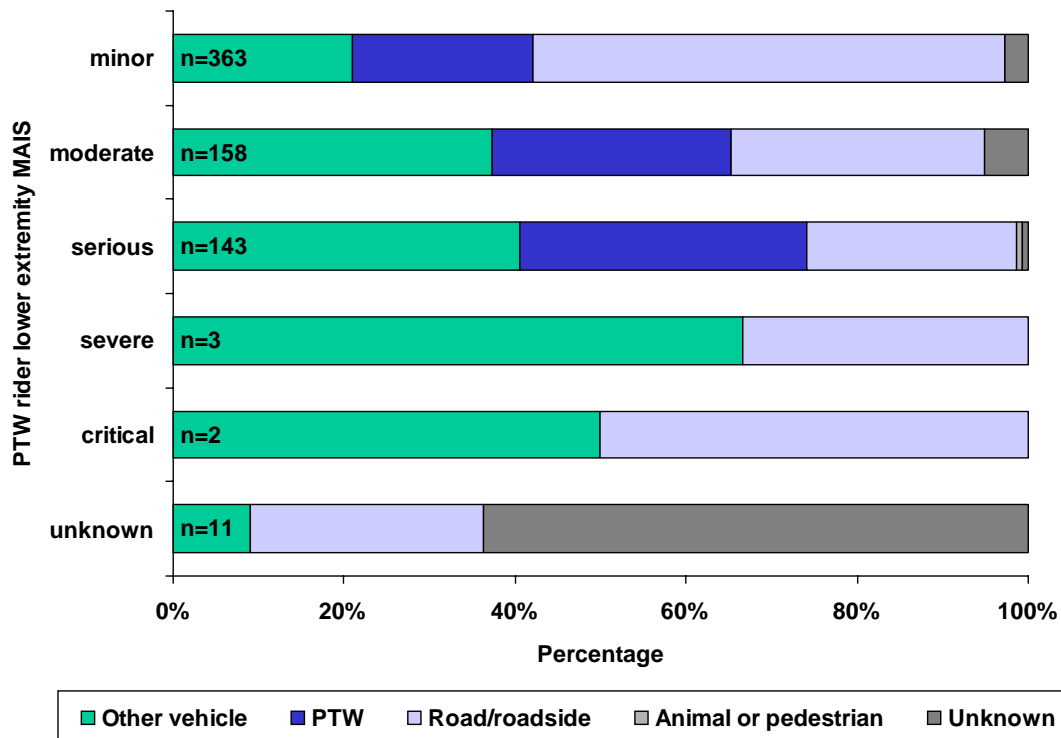

Figure 9.12: Distribution of rider lower extremity MAIS by collision contact code
 (Note: There were 241 cases in which the rider did not sustain a lower extremity injury)

PTW passenger injury

The PTW passenger injuries were also coded in detail using the same procedures as for the PTW riders. A total of 79 passengers were involved in the 921 accidents collected as part of the MAIDS accident investigations. The medical trauma status of the passengers is presented in Table 9.2. The data indicates that most of the passengers were treated in hospital for up to 8 days (62.0% of all passengers) with 18 additional passengers treated in hospital for more than 8 days or an unknown number of days. Four of the passengers were uninjured and received no medical treatment. There were five fatal passenger cases reported during the MAIDS research project. Note that there are 103 fatal cases reported and the sum of the fatal rider and passenger population equals 105. The reason for this difference is that there were two cases in which both the PTW rider and passenger were killed, thus explaining the lower number of cases with a reported death.

Table 9.2: PTW passenger trauma status

	Frequency	Percent
No trauma	4	5.1
First aid only	3	3.8
Hospital treatment up to 8 days	49	62.0
Hospital treatment more than 8 days	10	12.7
Hospital treatment, unknown number of days	8	10.1
Fatal (within 30 days)	5	6.3
Total	79	100.0

Figure 9.13 presents the distribution of the passenger injuries for those cases involving a passenger. There were a total of 227 passenger injuries reported, and most of these injuries were to the lower extremities (32.2% or 73 reported injuries). The next most frequently injured body region was found to be the head (24.2% or 55 reported injuries). A total of 41 upper extremity injuries were also reported. The data shown in Figure 9.13 may be found in Annex C, Table C.27.

The distribution of the passenger MAIS injuries is shown in Figure 9.14 and is very similar to the PTW rider injury distribution. The data shown in Figure 9.14 may be found in Annex C Table C.37.

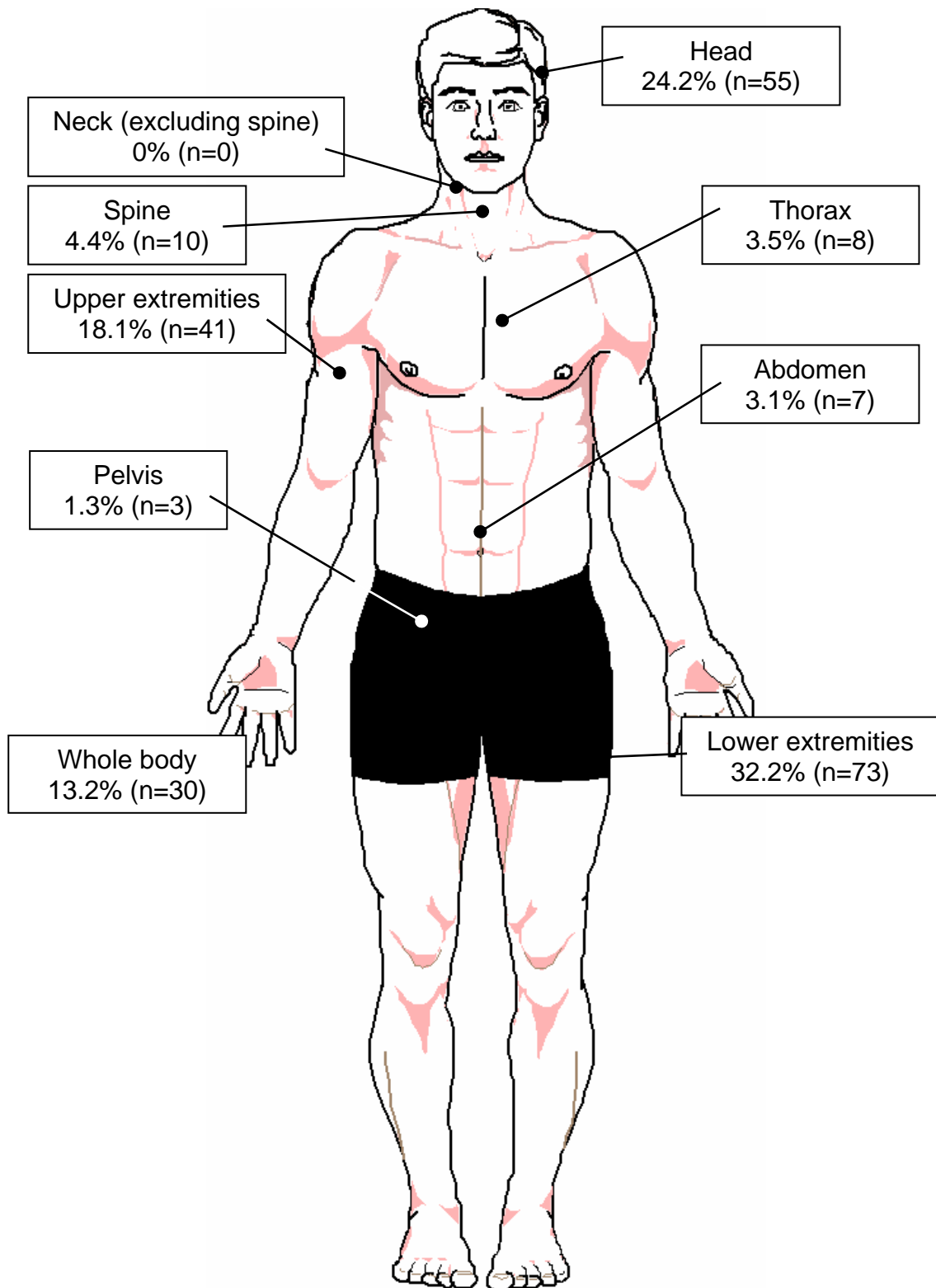

Figure 9.13: Summary of the distribution of PTW passenger injuries greater than AIS=1 (number in parenthesis indicates total number of reported injuries for that body region, total injuries = 227).

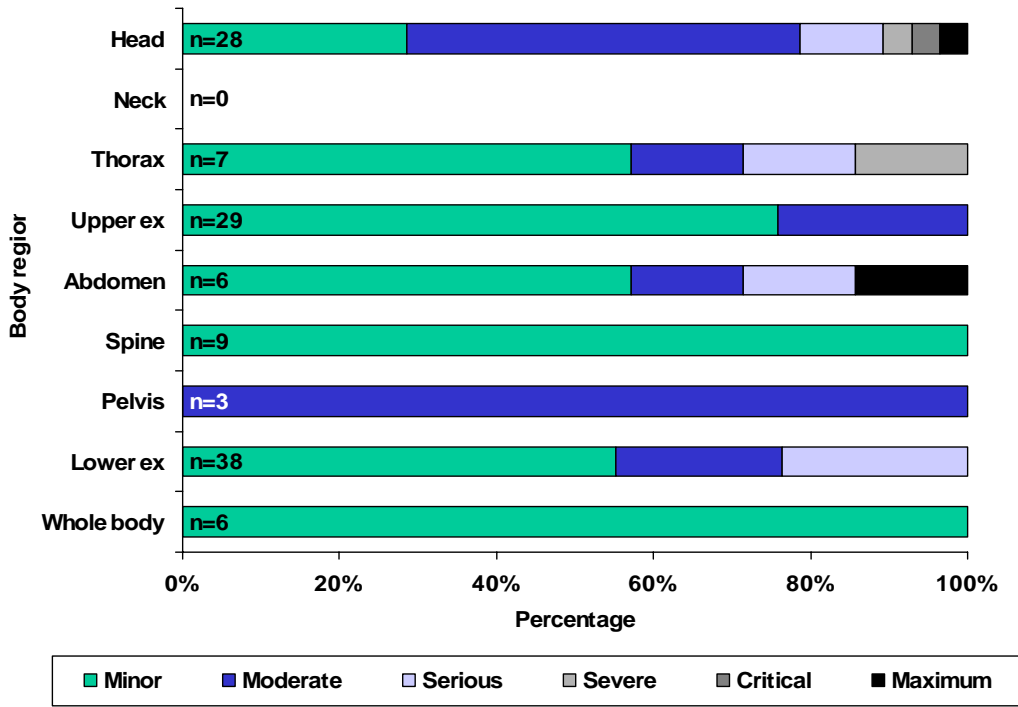

Figure 9.14: Cross-tabulation of passenger MAIS by body region

Injury and impact speed

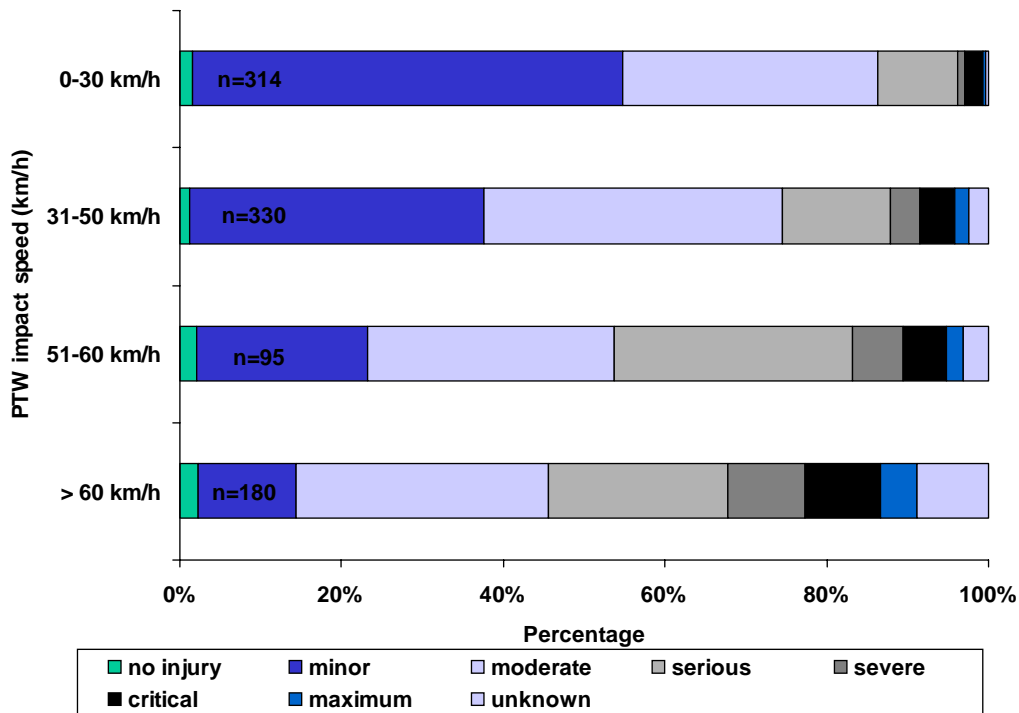

Figure 9.15: Cross-tabulation of rider MAIS by PTW impact speed

(Note: There were 2 cases with unknown impact speed and 15 cases where PTW rider was not injured)

Figure 9.15 shows the distribution of the rider MAIS injury when compared to the impact speed. The data clearly indicates that as the impact speed increases, the frequency of serious, critical and maximum injuries increases. The data also indicates that serious, critical and maximum injuries can also occur at accident speeds of less than 30 km/h. The data shown in Figure 9.15 may be found in Annex C Table C.38.

The effect of a passenger

Table 9.3 reports on the effect that a passenger had upon accident causation for those cases involving a passenger. The data presented indicates that in 82.2% of cases involving a passenger (n=79), the passenger made no contribution to the causation of the accident. In 7 cases, the passenger did contribute to the cause of the accident. These seven cases involved accidents where the passenger suddenly shifted, causing a control instability in the PTW and cases where the passenger had distracted the PTW rider, causing an accident.

Table 9.3: Passenger contribution to accident causation

	Frequency	Percent
No	65	82.2
Yes	7	8.9
Unknown	7	8.9
Total	79	100.0

Table 9.4 shows the effect of the rider/passenger interaction on the injuries sustained by both the rider and the passenger. In most cases, the interaction between the rider and passenger had no effect upon injuries to either rider or passenger. The injuries for passenger and rider were reportedly increased in two cases, while the injuries to the rider and passenger were decreased in twenty cases.

Table 9.4: Effect of rider/passenger interaction on injury causation

	Frequency	Percent
No effect	56	70.8
Rider injuries increased	1	1.3
Rider injuries decreased	2	2.5
Passenger injuries increased	1	1.3
Passenger injuries decreased	18	22.8
Unknown	1	1.3
Total	79	100.0

Helmets

A significant effort was placed upon understanding the material properties and accident performance of the clothing used by the PTW rider and passenger. Information was gathered by detailed interview and the inspection of the clothing worn by all riders and passengers. Since performance of clothing is directly related to the type of materials, in-depth training was provided to each team member so that they could easily identify the product, the manufacturer and the material. Whenever possible and permissible, investigators took photographs of the clothing for the case data files.

The most significant form of personal protective equipment worn by any PTW rider or passenger is the safety helmet. Table 9.5 indicates that the great majority of PTW riders wore a helmet at the time of the accident (90.4% or 833 cases). Helmets were mandatory for all riders in the five sampling regions yet 73 cases reported a PTW rider who was not wearing a helmet at the time of the collision.

When the accident data is compared to the exposure data, the data indicates that for both samples, helmet usage was between 90.4% and 92.3% and helmet non-usage was 8% in both groups. This indicates that there is no significant difference between the accident and exposure samples. Therefore, the use of a helmet neither increased nor decreased the rider's risk of being in an accident.

Table 9.5: Rider helmet usage

	Accident data		Exposure data	
	Frequency	Percent	Frequency	Percent
Helmet not worn	73	8.0	70	7.6
Helmet worn	833	90.4	852	92.3
Unknown	15	1.6	1	0.1
Total	921	100.0	923	100.0

When the PTW rider helmet usage data is evaluated according the PTW legal category (see Table 9.6), more L1 riders were found to be not wearing a helmet at the time of the accident (17.3% versus 0.8%). Almost all of the L3 riders were wearing a helmet at the time of the accident (98.7% of all L3 vehicle cases).

Table 9.6: Cross-tabulation of PTW rider helmet usage by PTW legal category

	L1 vehicles		L3 vehicles		Total	
	Frequency	Percent of L1	Frequency	Percent of L3	Frequency	Percent
No	69	17.3	4	0.8	73	7.9
Yes	317	79.7	516	98.6	833	90.5
Unknown	12	3.0	3	0.6	15	1.6
Total	398	100.0	523	100.0	921	100.0

Table 9.7 indicates that most riders preferred to wear full face helmets (67.6% or 623 cases), Open face helmets and half type helmets were reported with near equal frequency (9.1% and 8.9% respectively).

Table 9.7: Rider helmet type

	Frequency	Percent
Not a motorcycle helmet	4	0.4
Half type, used	82	8.9
Open face, used	84	9.1
Full face, used	623	67.6
Unknown type used	55	6.0
No helmet used	73	8.0
Total	921	100.0

Table 9.8 indicates the effect that the PTW helmet had upon any head injuries sustained by the rider. This determination of the effect of wearing a helmet was based

upon a detailed analysis of the rider kinematics as well as a review of any head injuries reported. If the analysis revealed that there was head contact (e.g., damage was noted on the helmet) and there was no reported injury, then the helmet was coded as preventing injury. If there was evidence of helmet contact and the rider had documented head injury, then the helmet was considered to have reduced the severity of the injury. There were some cases reported in which the helmet either had no effect upon the head injury (such as during inertial type loading of the head). The data indicates that in 68.7% of all cases, the helmet was capable of preventing or reducing the head injury sustained by the rider (i.e., 33.2% + 35.5%). In 3.6% of all cases, the helmet was found to have no effect upon head injury.

Table 9.8: Effect of helmet upon head injury (PTW rider)

	Frequency	Percent
No helmet present, injury to head occurred	62	6.7
Helmet worn, but no effect on head injury	33	3.6
Yes, coverage present and reduced injury	306	33.2
Yes, coverage present and prevented injury	327	35.5
No injury producing contact in region	152	16.5
Other	4	0.4
Unknown	37	4.1
Total	921	100.0

Table 9.9 shows passenger helmet usage for the 79 MAIDS cases that involved a passenger. 21.5% of all passengers involved in an accident were found to be not wearing a helmet at the time of the accident. This represents a higher percentage of unhelmeted passengers when compared to PTW riders (i.e., 21.5% versus 7.9%). The majority of passengers were wearing a full face helmet (55.7%). The remainder of helmeted passengers chose either a half type helmet (6.3%, 5 cases) or an open face helmet (7.6%, 6 cases). There were seven cases in which the helmet type was unknown (see Table 9.10).

Table 9.9: Passenger helmet usage

	Frequency	Percent
Helmet not worn	17	21.5
Helmet worn	55	69.6
Unknown	7	8.9
Total	79	100.0

Table 9.10: Passenger helmet type

	Frequency	Percent
Half type, used	5	6.3
Open face, used	6	7.6
Full face, used	44	55.7
No helmet used	17	21.5
Unknown / n.a.	7	8.9
Total	79	100.0

Table 9.11 shows the number of cases in which the helmet was ejected from the rider's head. This assessment was based upon a detailed analysis of the rider kinematics

as well as a detailed examination of the PTW rider helmet. In most cases, the evidence of helmet ejection was quite obvious (e.g., the helmeted rider sustained a direct head injury such as a laceration or an abrasion and the helmet was found some distance from the point of rest of the PTW rider). The data indicates that in 9.1% of cases, the helmet was ejected from the rider's head at some point during the accident.

Table 9.11: Rider helmet retention

	Frequency	Percent
Retained	679	73.7
Ejected	84	9.1
No helmet worn	73	7.9
Other	1	0.1
Unknown	84	9.2
Total	921	100.0

Table 9.12 indicates that for those cases in which a helmet ejection occurred, there were 58 cases in which the reported ejection was because the rider failed to fasten helmet chin strap or had removed it. There were 13 cases in which the helmet ejections were due to some type of damage to the helmet during the collision sequence.

Table 9.12: Cause of rider helmet ejection

	Frequency	Percent
Due to improper fastening or modification of the retention system by the wearer	58	6.3
Due to helmet damage	13	1.4
No helmet/ no ejection	751	81.6
Unknown if helmet ejected	99	10.7
Total	921	100.0

Table 9.13 presents the frequency distribution of the PTW passenger helmet retention data. There were only 6 reported cases in which the passenger helmet was ejected, and all of these ejections were due to either loose fastening or a poor helmet fit.

Table 9.13: Passenger helmet retention

	Frequency	Percent
Retained	48	60.7
Ejected	6	7.6
No helmet	18	22.8
Unknown	7	8.9
Total	79	100.0

Upon completion of the helmet use analysis, the MAIS injury data for helmeted riders were partitioned in order to understand the relationship between helmet use and MAIS injury.

Figure 9.16 shows the distribution of MAIS versus impact speed for helmeted PTW riders. Seventy percent of helmeted PTW riders sustained no injury, even at impact speeds above 61 km/h. Once again, the data did not indicate any trends with respect to helmeted rider MAIS and impact speed. The data shown in Figure 9.16 may be found in Annex C Table C.39.

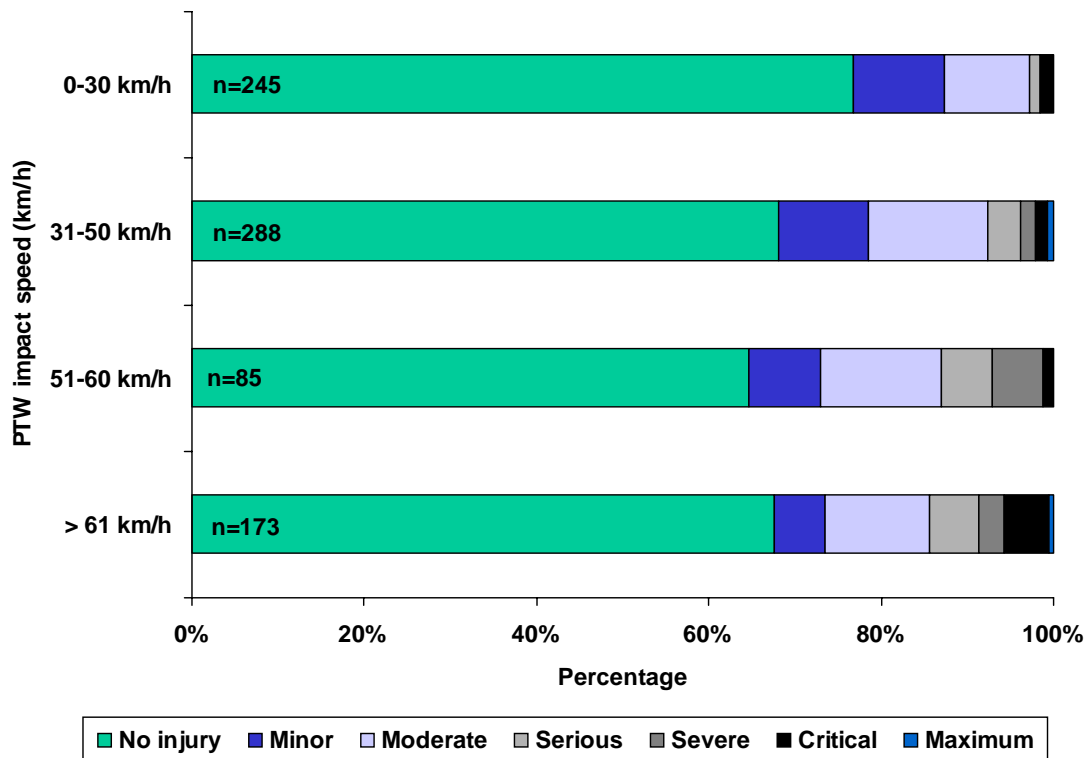

Figure 9.16: Cross-tabulation of helmeted rider's head MAIS and PTW impact speed
(Note: There were 57 cases in which it was not known if the rider was helmeted)

Clothing

All clothing for the rider and passenger was documented for each MAIDS case. Figures 9.17 and 9.18 show the distribution of PTW rider and passenger upper torso clothing materials worn at the time of the accident.

Table 9.14 indicates that the upper torso clothing prevented or reduced AIS 1 injury in 64.6% of all cases (i.e., 45.4% + 19.2%). There were 58 cases in which there was no upper torso coverage and injury occurred.

Table 9.14: Effect of PTW rider upper torso clothing on injury

	Frequency	Percent
Coverage not present and injury occurred	58	6.3
Coverage had no effect on injury prevention	76	8.3
Yes, coverage present and reduced injury	418	45.4
Yes, coverage present and prevented injury	177	19.2
No injury producing contact in region	135	14.7
Unknown	57	6.1
Total	921	100.0

Table 9.15 indicates the effect of the upper torso clothing upon the PTW passenger injuries. Similar to the PTW rider, the upper torso clothing reduced and or prevented injury in 49.4% of all cases involving a passenger (i.e., 30.4+19.0). There were more cases in which the passenger did not sustain any injury-producing contact in the upper torso region (20 cases, 30%). This is most probably related to differences in rider and passenger kinematics during the accident.

Table 9.15: Effect of PTW passenger upper torso clothing on injury

	Frequency	Percent
Coverage not present and injury occurred	4	5.1
Coverage had no effect on injury prevention	5	6.3
Yes, coverage present and reduced injury	24	30.4
Yes, coverage present and prevented injury	15	19.0
No injury producing contact in region	20	25.3
Unknown	11	13.9
Total	79	100.0

Table 9.16 indicates that the lower torso clothing provided injury reduction or injury prevention in 61.3% of all cases. There were 91 cases (9.9%) in which the lower torso coverage was not in a region where the rider sustained injuries (i.e., short pants were worn at the time of the accident). There were also 109 cases in which the lower torso clothing had no effect upon injury. These are probably cases in which the lower torso of the rider was struck directly or run over by the OV.

Table 9.16: Effect of PTW rider lower torso clothing on injury

	Frequency	Percent
Coverage not present and injury occurred	91	9.9
Coverage had no effect on injury prevention	109	11.8
Yes, coverage present and reduced injury	462	50.2
Yes, coverage present and prevented injury	102	11.1
No injury producing contact in region	111	12.0
Unknown	46	5.0
Total	921	100.0

The PTW passenger lower torso clothing was found to be effective at reducing or preventing injury (e.g., 36.7%+8.9%=45.6%) and there were 12 cases (15.2%) in which the lower torso clothing had no effect upon injury prevention. Similar to the PTW rider, these cases are most likely due to direct contact with the OV.

Table 9.17: Effect of PTW passenger lower torso clothing on injury

	Frequency	Percent
Coverage not present and injury occurred	8	10.1
Coverage had no effect on injury prevention	12	15.2
Yes, coverage present and reduced injury	29	36.7
Yes, coverage present and prevented injury	7	8.9
No injury producing contact in region	13	16.5
Unknown	10	12.6
Total	79	100.0

Table 9.18 indicates the effectiveness of the PTW rider footwear upon AIS 1 injuries. The data indicates that there were 31 cases in which the footwear was not present and injury occurred. There were an additional 42 cases in which the coverage had no effect upon reducing AIS 1 injuries. Overall, 48.7% of the passengers involved in MAIDS accidents used footwear that either reduced or prevented AIS 1 injuries (i.e., 27.7%+21.0%). The remainder of passengers experienced no contact to the foot region.

Table 9.18 Effect of PTW rider footwear on injury

	Frequency	Percent
Coverage not present and injury occurred	31	3.4
Coverage had no effect on injury prevention	42	4.5
Yes, coverage present and reduced injury	255	27.7
Yes, coverage present and prevented injury	193	21.0
No injury producing contact in region	346	37.6
Unknown	54	5.8
Total	921	100.0

Table 9.19 shows the effect of the passenger footwear upon AIS 1 injuries. The data indicates that half of the passengers received no contact to the foot region. AIS 1 injuries were reduced or prevented in 29.1% of all cases involving a passenger (i.e., 19.0%+10.1%).

Table 9.19: Effect of PTW passenger footwear on injury

	Frequency	Percent
Coverage not present and injury occurred	4	5.1
Coverage had no effect on injury prevention	5	6.3
Yes, coverage present and reduced injury	15	19.0
Yes, coverage present and prevented injury	8	10.1
No injury producing contact in region	33	41.8
Other	1	1.3
Unknown	13	16.4
Total	79	100.0

Table 9.20 indicates that when gloves are worn, they can reduce or prevent AIS 1 injuries (i.e., 23.6% + 19.9%=43.5%). The data also indicates that the rider's hands were not contacted directly in 35.9% of the cases. This may be underestimated since hand abrasions may not always be reported during a medical examination which involves much more serious internal and external injuries.

Table 9.20: Effect of gloves on PTW rider injury

	Frequency	Percent
Coverage not present and injury occurred	102	11.1
Coverage had no effect on injury prevention	21	2.3
Yes, coverage present and reduced injury	217	23.6
Yes, coverage present and prevented injury	183	19.9
No injury producing contact in region	331	35.9
Unknown	67	7.2
Total	921	100.0

Table 9.21 shows the effectiveness of gloves upon AIS 1 passenger injuries. The data indicates that the gloves were effective in preventing or reducing AIS 1 injury for 25.3% of all cases (i.e., 15.2%+10.1%). Three were 13 cases in which no gloves were worn and injury occurred, and a further 12 cases in which the effect of gloves could not be determined.

Table 9.21: Effect of gloves on PTW passenger injury

	Frequency	Percent
Coverage not present and injury occurred	13	16.5
Coverage had no effect on injury prevention	2	2.5
Yes, coverage present and reduced injury	12	15.2
Yes, coverage present and prevented injury	8	10.1
No injury producing contact in region	32	40.5
Unknown	12	15.2
Total	79	100.0

Figures 9.17 and 9.18 demonstrate the different types of clothing worn by the riders and passengers that were involved in accidents collected during this research project.

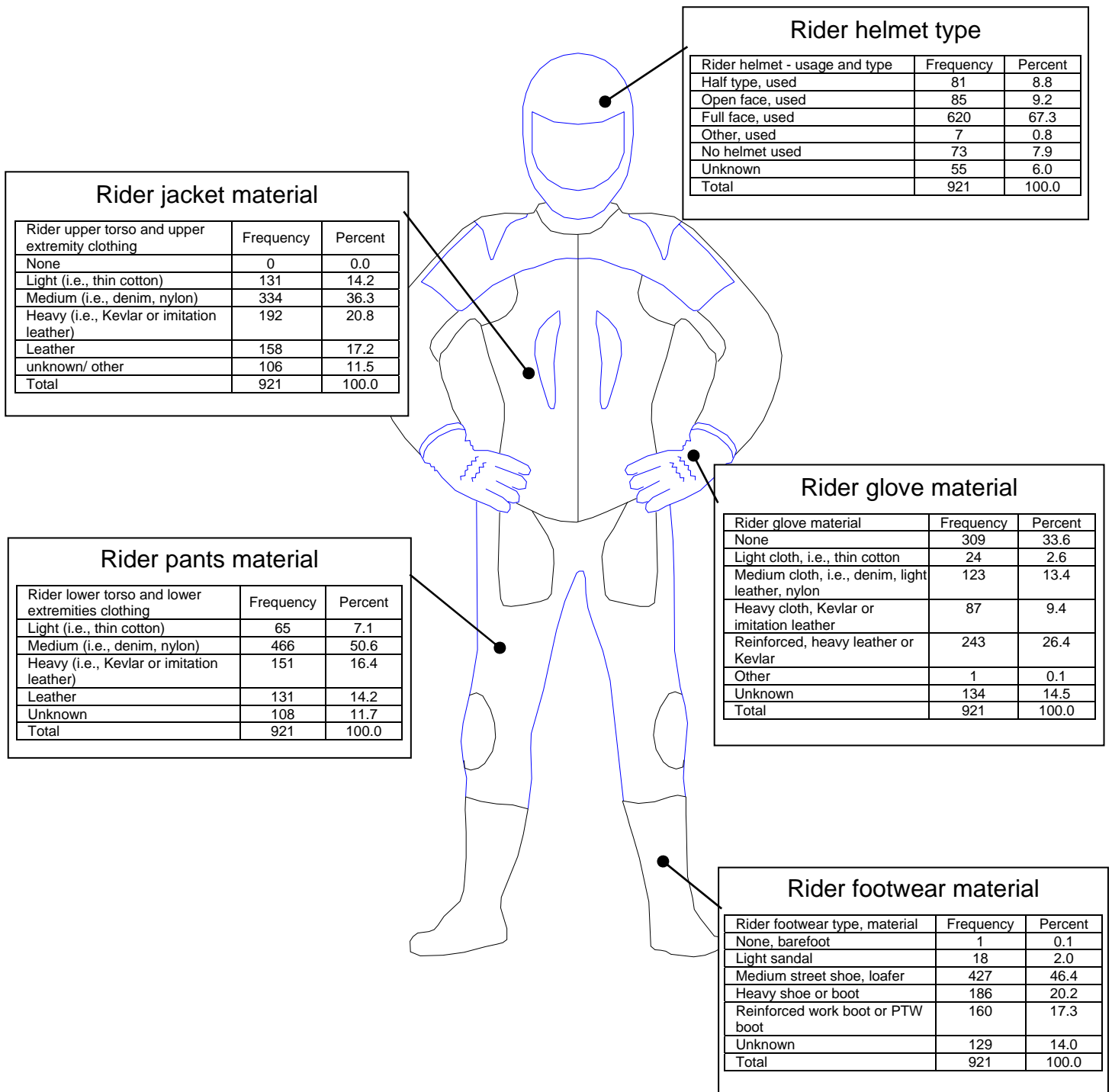

Figure 9.17: Distribution of PTW rider clothing

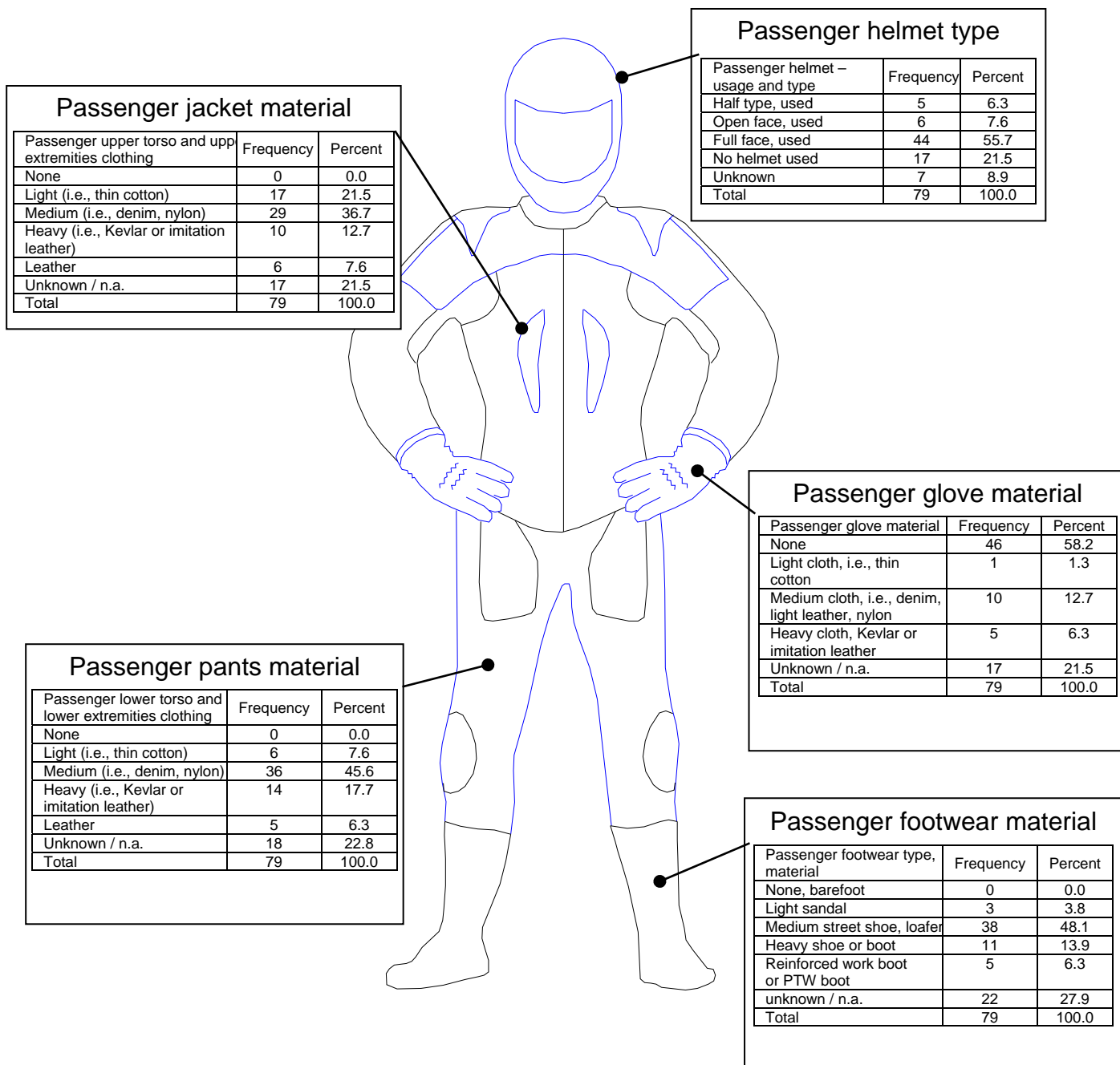

Figure 9.18: Distribution of PTW passenger clothing

Findings on rider protection

- The most frequently reported first collision contact point for the PTW was the centre front (28.9% of all cases).
- The most frequently reported first collision contact point for the OV was the left side (21.9% of all cases).
- A total of 3644 injuries were reported. Most injuries were reported to be minor lacerations, abrasions or contusions.
- Lower extremity injuries made up 31.8% of all injuries, followed by upper extremity injuries which made up 23.9% of all injuries. Head injuries accounted for 18.7% of all reported injuries.
- Most upper and lower extremity injuries occurred as a result of impacts with the OV or the roadway.
- There were cases of helmets coming off the riders head due to improper fastening of the retention system or helmet damage during the crash sequence.
- In 69% of cases, helmets were found to be effective at preventing or reducing the severity of head injury.

10.0 Rationale for action

The 921 on-scene, in-depth accident investigations have provided a large volume of data related to the general characteristics of PTW accidents; including accident causation and rider and passenger injury information. The outcome of these investigations can be considered in the identification, development and introduction of countermeasures.

The major findings of this study are as follows:

1. In 37% of cases, the primary accident contributing factor was a human error on the part of the PTW rider. In some situations, the human errors that occurred involved skills that were beyond those that typical drivers or operators might currently have. This is often due to the extreme circumstances of some of the accident cases, including an insufficient amount of time available to complete collision avoidance. (*Sources: Tables 4.1, 5.23*)
2. Among the secondary contributing factors, PTW riders failed to see the other vehicle (OV) and they also made a large number of faulty decisions, i.e., they chose a poor or incorrect collision avoidance strategy. In 13% of all cases, there was a decision failure on the part of the PTW rider. (*Sources: Figure 4.1, Table C.5*)
3. The number of cases involving alcohol use among the PTW riders was less than 5%, which is low in comparison to other studies, but such riders were more likely to be involved in an accident. (*Source: Table 7.9*)
4. In comparison to the exposure data, unlicensed PTW riders, illegally operating a PTW for which a licence is required, have a significantly increased risk of being involved in an accident. (*Source: Table 7.5*)
5. PTW riders between 41 and 55 years of age were found to be under-represented, suggesting that they may have a lower risk of being involved in an accident when compared to other rider age categories. (*Source: Table 7.1*)
6. When compared with the exposure data, 18 to 25 year old riders were found to be over-represented. (*Source: Table 7.1*)
7. In 50% of cases, the primary accident contributing factor was a human error on the part of the OV driver. (*Source: Table 4.1*)
8. OV drivers holding PTW licences were less likely to commit a perception failure than those without a PTW licence, i.e., they did not see the PTW or its rider. (*Sources: Figure 7.8, Table C.17*)
9. In about 1/3 of accidents PTW riders and OV drivers failed to account for visual obstructions and engaged in faulty traffic strategies. (*Sources: Tables 4.11, 4.12, 8.3, 8.4, 8.5, 8.6*)
10. Traffic control violations were frequently reported, in 8% of the cases for PTW riders and in 18% for OV drivers. (*Sources: Tables 6.10, 6.12*)
11. Amongst the wide diversity of PTW accident and collision configurations that were observed in this study, not one configuration dominated. (*Sources: Figure 3.4, Table C.4*)
12. 90% of all risks to the PTW rider, both vehicular and environmental, were in front of the PTW rider prior to the accident. (*Source: Figure 5.6*)

13. Among the primary contributing factors, over 70% of the OV driver errors were due to the failure to perceive the PTW. (Sources: Figure 4.1, Table C.5)
14. The roadway and OVs were the most frequently reported collision partner. In 60.0% of accidents, the collision partner was a passenger car. (Source: Table 3.4)
15. Tampering in order to increase performance was observed by visual inspection in 17.8% of all moped cases. This value is lower than those reported in other studies. The exposure study only shows 12.3% of tampering. (Source: Table 5.30)
16. Only modified conventional street motorcycles were found to be over-represented in the accident data. There was no evidence of an increased risk associated with riding any other PTW style. (Sources: Figure 5.1, Table C.6)
17. There were PTW technical problems in less than 1% of the accidents. Most of these were related to the tyres, illustrating the need for regular PTW inspections by the owner. There were no cases found by the teams in which an accident was caused by PTW design or manufacture. (Sources: Tables 4.1, 4.25, 4.26)
18. In over 70% of the cases the PTW impact speeds were below 50 km/h. (Source: Table 5.14)
19. In 18% of all cases, PTW travelling speeds were greater than or less than the surrounding traffic and this speed difference was considered to be a contributing factor. (Source: Table 4.13)
20. 73.1% of all PTW riders attempted some form of collision avoidance immediately prior to impact. Of these, 32% experienced some type of loss of control during the manoeuvre. (Source: Table 5.2)
21. 90.4% of the PTW riders wore helmets. However, 9.1% of these helmets came off the wearer's head at some time during the accident, due to improper fastening or helmet damage during the accident. Overall, helmets were found to be an effective protective device to reduce the severity of head injuries. (Sources: Tables 9.5, 9.8, 9.11, 9.12)
22. 55.7% of PTW rider and passenger injuries were to the upper and lower extremities. The majority of these were minor injuries, e.g. abrasions, lacerations and contusions. Appropriate clothing was found to reduce, but not completely eliminate, many of these minor injuries. (Source: Figures 9.3, 9.13)
23. Roadside barriers presented an infrequent but substantial danger to PTW riders, causing serious lower extremity and spinal injuries as well as serious head injuries. (Source: Figure 6.1, Table C.9)
24. For PTW riders, a roadway maintenance defect caused the accident or was a contributing factor in 3.6% of all cases. (Source: Table 4.17)
25. For PTW riders, a traffic hazard caused the accident or was a contributing factor in 3.8% of all cases. (Source: Table 4.19)
26. Weather-related problems either caused the accident or contributed to accident causation in 7.4% of PTW accidents in the study. (Source: Table 4.23)

References

ANONYMOUS, Motorcycles - Test and Analysis Procedures for Research Evaluation of Rider Crash Protective Devices Fitted to Motorcycles, ISO 13232, International Organization for Standardization, Geneva, 2002.

Association of European Motorcycle Manufacturers (ACEM). *In-depth investigation of motorcycle accidents - Report on the Project Methodology and Process*, Brussels, 2003.

Association for the Advancement of Automotive Medicine (AAAM). *The abbreviated injury scale*. 1990 revision, 1998 update. Des Plaines (IL, U.S.A.).

BRESLOW, N.E., and DAY, N.E. 1980. *Statistical methods in cancer research*. Volume 1, The analysis of case control studies. World Health Organization, International agency for research on cancer.

HAWORTH, N., SMITH, R., BRUMEN, I. and PRONK, N. 1997. *Case Control Study of Motorcycle Crashes*. Monash University Accident Research Centre, CR 174 for the Federal Office of Road Safety, Department of Transport and Regional Development.

HURT, JR., HH., OUELLET, JV., and THOM, DR. 1981a. *Motorcycle accident cause factors and identification of countermeasures: volume I: technical report*. Final report. Washington DC: U.S. Department of Transportation.

HURT, JR., HH., OUELLET, JV., and THOM, DR. 1981b. *Motorcycle accident cause factors and identification of countermeasures: volume II: appendix/supplemental data*. Final report. Washington DC: U.S. Department of Transportation.

International Coordinating Committee of the Expert Group for Motorcycle Accident Investigations; of the Road Transport Research Programme; of the Directorate for Science Technology and Industry; of the Organization for Economic Cooperation and Development, OECD/DSTI/RTR/RS9/ICC. *Motorcycles: Common International Methodology for On-Scene, In-Depth Accident Investigation*, Paris, 2001.

NEWMAN, JA, and WEBSTER, GD. 1974. *The mechanics of motorcycle accidents*. In: Proceedings of the 18th Annual Conference of the American Association for Automotive Medicine, pp. 265-302.

NOORDZIJ, PC, FORKE, E., BRENDICKE, R. and CHINN, B. 2001. Integration of needs of moped and motorcycle riders into safety measures. Report D2001-5, SWOV Institute for Road Safety Research.

OTTE, D. WILLEKE, H. CHINN, B. DOYLE, D. and SHULLER, E. 1998. Impact mechanisms of helmet protected heads in motorcycle accidents – accident study of COST 327. In: Safety – Environment – Future II, proceedings of the 1998 International Motorcycle Conference (ifz No. 8).

PEDDER, JB, HURT, JR., HH., OTTE, D. 1979. *Motorcycle accident impact conditions as a basis for motorcycle crash tests*. In: Proceedings of the 12th NATO conference on Experimental Safety Vehicles.

Glossary

Abbreviated injury scale (AIS) - The categorization of injury severity which ranks injury severity from 0 to 6; 0 being no injury to 6 being currently unsurvivable/untreatable, representing a subjective medical consensus measure of the probability of dying (AIS 90).

Accident - Any collision of a motor vehicle on a public roadway which results in property damage and/or personal injury to the motorcycle rider or passenger.

Accident data sample – The accidents which have been collected within a given sample region according to part 2 of the OECD Common Methodology.

Accident investigation – The collection, synthesis, and analysis of data on human, vehicle, and environmental factors to identify accident and injury causation and countermeasures.

Concurrent exposure data sample – The concurrent exposure data collected within a given sample region according to part 2 of the OECD Common Methodology.

Contact injury - An injury which is due to contact with the environment, a vehicle or a vehicle component or another person or animal involved in the accident.

Contributing factors - Any human, vehicle or environmental factor which the investigator considers to have contributed to the overall outcome of the accident. The precipitating event may or may not be considered to be a contributing factor.

Database variable – A coded variable in the database

End-over, endo, reverse wheelie - An extreme forward pitching motion; typically resulting in the rider and the rear frame assembly going over the front wheel in the direction of travel.

Enduro A motorcycle sporting event or race on-road, off-road, and cross country from one point to another, usually lasting hours or days, and emphasizing timing, speed, and reliability. Also a motorcycle intended to compete in such an event.

Environmental factor - Any factor, other than the vehicle factors or human factors, which has any effect on the accident or injury causation during the pre-crash, crash, or post-crash time periods.

Factor – An independent variable

Fatal injuries - One or more injuries which result in death within 30 days.

First collision contact - The portion or area of a vehicle where the earliest, main collision force, is applied during an accident.

Gross mass: The total permissible mass of a vehicle when it is fully equipped, including occupants, luggage and parcel or luggage rack load. This value is designated by the manufacturer and often abbreviated as GVM.

Hazard – A temporary traffic obstruction.

High-side - A motorcycle sideways upset involving an extreme rolling and capsizing motion, where the upper part of the vehicle rolls towards the direction of travel.

Impact speed - The magnitude of the velocity relative to the ground, immediately prior to impact.

Intersection - Any level crossroad, junction or fork, including the open areas formed by such crossroads, junctions or forks.

Low side (Slide-out) - A vehicle upset involving an extreme rolling and capsizing motion, where the upper part of the vehicle rolls away from the direction of travel, e.g., a lay down.

Negotiating a bend - A vehicle following any roadway which is curved in the horizontal plane.

Over represented value – a value which occurs with a statistically significant greater frequency than would be expected, assuming there were no differences associated with that value (i.e., the difference in frequencies cannot be explained by random variation).

Pitch-weave - An interaction that can occur between the pitching and weaving motions, typically while cornering, when the natural frequencies of these modes of motion are approximately the same. The result is a combined rolling, yawing, and pitching motion, in general. Also known as “cornering weave.”

Point of impact (POI) - A vertical projection of a point to the ground representing the location of impact in a given accident.

Point of rest (POR) - The final location of any vehicle, rider, passenger or object following a collision.

Precipitating event - The failure or manoeuvre that immediately led to the accident.

EXAMPLE: An automobile turns into the path of an oncoming motorcycle. The automobile turning is the action of the precipitating event.

EXAMPLE: A motorcycle rider is alcohol-involved and runs off the road. The motorcycle running off the road is the precipitating event, which may be followed by loss of control, collision with a fixed object, etc. The time when the rider began consuming alcohol is interesting in the accident causation, but is totally unrelated to the crash events.

EXAMPLE: Motorcycle is travelling through an intersection. The motorcycle rider observes that the light has changed to red; however, the MC rider feels that he cannot stop safely and proceeds to accelerate and travel through the intersection at a high rate of speed. A large truck is travelling in a direction normal to the path of travel of the motorcycle and observes a green light and proceeds to enter the intersection. As a result of both vehicles actions, a collision occurs. The precipitating event is the failure of the motorcycle to stop. If the motorcycle rider had acted properly (i.e., stopped at the red light), the accident would not have occurred.

Primary contributing factor - The contributing factor which the investigator considers to have contributed the most to the overall outcome of the accident.

Risk factor – A hypothetical causal factor for accidents or injuries

Roadway design defect - Any deviation from applicable national or local highway design standards for any cause

EXAMPLE: Unmarked sharp curve

Roadway maintenance defect - Any deviation from applicable roadway maintenance standards.

EXAMPLE: Construction debris, large hole in pavement

Single vehicle accident - A motorcycle accident in which no other vehicle is involved in either causation or collision.

Slide-out (Low side) - A vehicle upset involving an extreme rolling and capsizing motion, where the upper part of the vehicle rolls away from the direction of travel, e.g., a lay down.

Statistically significant – A situation in which the observed differences in frequencies is great enough that it is improbable (i.e., the probability is less than 0.05) that this difference in frequencies is only due to random variation.

Swerve - A sudden deviation in the path of the motorcycle as a result of turning actions.

Traffic hazard - A danger or risk present on a roadway excluding roadway design or maintenance defects.

EXAMPLE: Dead animal, dropped box, inoperable vehicle.

Traffic control – Any device or signage that is meant to control the movement of traffic.

Traffic control defect or malfunction – Any traffic control that does not perform as intended.

EXAMPLE: Inoperable traffic control signals, damaged stop sign.

Under represented value – A value which occurs with a statistically significant lesser frequency than would be expected, assuming there were no differences associated with that value (i.e., the difference in frequencies cannot be explained by random variation).

Variable – A specific piece of information that can have different values or categories in a range or set (e.g., helmet colour).

Wheelie - A large amplitude pitch-up condition where the front wheel lifts off the ground for a period of time; usually caused by a combination of rider throttle control and body movement fore and aft.

Annex A

Participants in the MAIDS Research Project

MAIDS Project Partners

André Brisaer – European Commission
Willem Vanbroeckhoven – CIECA
Wilhelm Petzholtz – CEICA
David Ward – AIT/FIA
Bernard Legrand – CEA
Klaus Langweider – GDV
Rob Rasor – FIM/AMA
Guy Maître – FIM
Bob Tomlins – FEMA
John Chatterton-Ross – BMF

MAIDS Management Group (MMG)

Nick Rogers - IMMA – chairman
Hans Van Driessche – Honda Motor Europe Ltd.
Susanne Meis – BMW A.G.
Fabio Fazi – Ducati Motor Holding S.p.A.
Klaus Zobel – Harley-Davidson Europe Ltd.
Garry Brumfitt – Harley-Davidson Europe Ltd.
Reiner Brendicke – IVM e.V.
Marc Bonnin – Peugeot Motorcycles
Giovanni Moscato – Piaggio & C. S.p.A.
Jan Paul Peters – Yamaha Motor Europe
Akihiko Nakamura – Suzuki International Europe GmbH
Ian Ashdown – Suzuki Motor Corporation
Julie Baker – Triumph Motorcycles Ltd.

MAIDS Expert Group (MEG)

Thomas Goetz - BMW - chairman
Hans Van Driessche – Honda Motor Europe Ltd.
Fabio Fazi – Ducati Motor Holding S.p.A.
Eric Lundquist – Harley-Davidson Ltd.
Nourredine Osmani – Peugeot Motorcycles
Marco Pieve – Piaggio & C. S.p.A.
Jan Paul Peters – Yamaha Motor Europe
Takenori Yamamoto – Honda R&D Co. Ltd.
Takeshi Yamazaki – Honda R&D Co. Ltd.

MAIDS Research Teams

Pavia (Italy)

Principal Investigator: Alessandra Marinoni
Program Manager: Mario Comelli
Accident investigation and reconstruction: Mattia Sillo
Data manager, inter-team liaison: Eugenia Torre
Accident investigation: Davide Campagnoli
Senior interviewer: Paola Morardo
Interviewer: Elisa Trivi
Data collection: Umberto Alesso
Data collection: Roberto Busconi
Data collection: Christian De Maddalena
Data collection: Paolo Micheletti
Data entry: Paolo Pogliani
Data quality control: Carlo Lombardo
Vehicle factors: Paolo Gavana
Medical consultant: Claudio Pavesi
Medical pathology consultant: Claudia Castiglioni

REGES (Spain)

Principal investigator: José Luis Pedragosa
Program manager: David Cami
Human factors: Montse Parcerisa, Georgina Pedragosa, Eva Higuera
Mechanical factors: Josep González
Environmental factors: José Manuel Pesqueira
Concurrent exposure analyst: Federico Acosta
Data analyst: Lourdes Comas

CEESAR (France)

Principal Investigator: Thierry Hermitte
Principal Investigator: Yves Page
Accidentologist: Maxime Moutreuil
Accidentologist: Alain Martin
Accidentologist (secondary safety): Dominique Villeforceix
Team medical and biomechanical consultant: Hervé Guillemot

ARU-MUH (Germany)

Principal Investigator: Professor Dietmar Otte
Program Manager: Ralph Mueller
Team member: Fabian Stille

TNO (Netherlands)

Principal Investigator: Dr. Herman Mooi

Program Manager: Dimitri Margaritis

Accident investigator and statistical expert: Ydo de Vries

Accident investigator and medical specialist: Walter Kool

Team members: Jaap Postma, Jodi Kooijman, Harrie van Oirsouw, Flip van Kesteren, Herman van Vlaardingen, Gilbert Bouwens, Koen Cheung, Allan Hart, Eddy Ansari, Floris van der Wolf, Erik Jonk

MAIDS Consultants

Paul Caille – Eresman (Toulouse, France)

Alessandra Marinoni – University of Pavia (Pavia, Italy)

Mario Comelli - University of Pavia (Pavia, Italy)

Domenico Magazzù- University of Pavia (Pavia, Italy)

Mirella Bottazzi - University of Pavia (Pavia, Italy)

Rosa Pezzuto - University of Pavia (Pavia, Italy)

Paolo Ciccarese - University of Pavia (Pavia, Italy)

Terry Smith - Dynamic Research, Inc. (Los Angeles, USA)

Annex B

Description of the chi-square statistic

The chi-square significance test measures whether or not the frequency of an observed factor (e.g., rider age in the accident data) is significantly different than the expected frequency for that factor (e.g., rider age in the exposure data). The chi-square statistic assumes that the two factors are completely independent, i.e., a variable value in the accident data is not affected and does not affect a variable value in the petrol station exposure data.

In case control studies, the chi-square statistic is calculated by finding the difference between each observed case frequency (i.e., accident data) and each expected control frequency (i.e., exposure data), squaring them, dividing each by the control frequency, and taking the sum of the results:

$$\chi^2 = \sum \frac{(O - E)^2}{E}$$

where:

O = an observed frequency (i.e., the accident data frequency)

E = an expected frequency, based on the exposure data

Table B.1: Example distribution of rider-age

		Data source		Total
		Accident data	Exposure data	
Rider age	Between 22-25 yrs	132	84	216
	Not between 22-25 yrs	789	839	1628
Total		921	923	1844

The Pearson chi-square statistic for the data presented in Table B.1 12.2 and the reported two-sided asymptotic significance value is reported as less than 0.0001, indicating that the results are statistically significant. The corresponding odds ratio is 1.67, indicate that rider age between 22 -25 years (i.e., the facto of interest) is a potentially over-represented factor.

Among statisticians a chi-square significance value of 0.05 is a conventionally accepted threshold of statistical significance; values of less than 0.05 are commonly referred to as "statistically significant." In practical terms, a chi-square level of significance of less than 0.05 means that if, in fact, there was no association in the population between the independent and dependent variables, the observed association would be expected to occur by chance less than 5 times in 100 samples of the type we used. Thus, when the chi-square level of significance is less than 0.05, we can be confident in rejecting the possibility that no association exists between the independent and dependent variables (i.e., the accident data and the exposure data are significantly different and therefore, a given factor is over or under represented). As the chi-square level of significance

increases above .05 the likelihood that the observed association occurred by chance increases (i.e., the accident data and the exposure data are not significantly different and therefore, a given factor is neither over nor under represented).

The chi-square test statistic relies upon the following assumptions and approximations:

1. The conclusions drawn from the test are applicable to a population such that this sample can be considered to be a random sample drawn from the population;
2. The data were independently sampled and each value of a given variable is independent of the other values;
3. When the data are arrayed in a table, the categories for the rows and columns are mutually exclusive and exhaustive. That is, each value of a given variable in the accident or concurrent exposure data sample is represented in one and only one cell in the table;
4. The expected frequency for each cell in the table is equal to 5 or greater.
5. For purposes of preliminary analysis, there are no confounding values present which influence the outcome of a given variable;
6. If unknown values are present, they are randomly distributed within the data sample.

All chi-square statistical tests presented in this report have been done using Yates' correction, which is a conservative adjustment to the chi-square statistic which gives a better approximation to the binomial distribution.

Annex C

Detailed data tables

Table C.1: PTW collision partner by type of area

Frequency Row Percent Column Percent Total Percent		Type of area			Total
		urban	rural	other	
PTW collision partner	Passenger car	427	107	19	553
		77.2	19.3	3.4	100.0
		64.1	46.7	73.1	60.0
		46.4	11.6	2.1	60.0
	PTW	42	22	0	64
		65.6	34.4	0.0	100.0
		6.3	9.6	0.0	6.9
		4.6	2.4	0.0	6.9
	Truck/SUV/bus/	63	13	1	77
		81.8	16.9	1.3	100.0
		9.5	5.7	3.8	8.4
		6.8	1.4	0.1	8.4
	Bicycle/pedestrian	15	3	1	19
		78.9	15.8	5.3	100.0
		2.3	1.3	3.8	2.1
		1.6	0.3	0.1	2.10
	Fixed object	28	45	1	74
		37.8	60.8	1.4	100.0
		4.2	19.7	3.8	8.0
		3.0	4.9	0.1	8.0
	Roadway	51	28	4	83
		61.4	33.7	4.8	100.0
		7.7	12.2	15.4	9.0
		5.5	3.0	0.4	9.0
	Parked vehicle	21	4	0	25
		84.0	16.0	0.0	100.0
		3.2	1.7	0.0	2.7
		2.3	0.4	0.0	2.7
	Animal	2	1	0	3
		66.7	33.3	0.0	100.0
		0.3	0.4	0.0	0.3
		0.2	0.1	0.0	0.3
	Other	17	6	0	23
		73.9	26.1	0.0	100.0
		2.6	2.6	0.0	2.5
		1.8	0.7	0.0	2.5
	Total	666	229	26	921
		72.3	24.9	2.8	100.0
		100.0	100.0	100.0	100.0
		72.3	24.9	2.8	100.0

Table C.2: Time of day accident occurred

This is a confidential draft document and is the property of ACEM - It is not to be copied or distributed without the permission of ACEM - Avenue de la Joyeuse Entrée 1 – 1040 Brussels
tel. + 32 (2) 230 97 32 – acembike@acembike.org

			fatal rider or passenger		Total
			non fatal	fatal	
Time of day accident occurred	00:01 - 1:00	Frequency	16	3	19
		% within fatal rider or passenger	2.0%	2.9%	2.1%
	1:01 - 2:00	Frequency	3	1	4
		% within fatal rider or passenger	0.4%	1.0%	0.4%
	2:01 - 3:00	Frequency	3	0	3
		% within fatal rider or passenger	0.4%	0.0%	0.3%
	3:01 - 4:00	Frequency	1	0	1
		% within fatal rider or passenger	0.1%	.0%	0.1%
	4:01 - 5:00	Frequency	0	1	1
		% within fatal rider or passenger	0.0%	1.0%	0.1%
	5:01 - 6:00	Frequency	10	2	12
		% within fatal rider or passenger	1.2%	1.9%	1.3%
	6:01 - 7:00	Frequency	26	2	28
		% within fatal rider or passenger	3.2%	1.9%	3.0%
	7:01 - 8:00	Frequency	57	5	62
		% within fatal rider or passenger	7.0%	4.9%	6.7%
	8:01 - 9:00	Frequency	48	6	54
		% within fatal rider or passenger	5.9%	5.8%	5.9%
	9:01 - 10:00	Frequency	26	0	26
		% within fatal rider or passenger	3.2%	0.0%	2.8%
	10:01 - 11:00	Frequency	36	1	37
		% within fatal rider or passenger	4.4%	1.0%	4.0%
	11:01 - 12:00	Frequency	41	1	42
		% within fatal rider or passenger	5.0%	1.0%	4.6%
	12:01 - 13:00	Frequency	47	8	55
		% within fatal rider or passenger	5.7%	7.8%	6.0%
	13:01 - 14:00	Frequency	38	4	42
		% within fatal rider or passenger	4.6%	3.9%	4.6%
	14:01 - 15:00	Frequency	66	6	72
		% within fatal rider or passenger	8.1%	5.8%	7.8%
	15:01 - 16:00	Frequency	55	8	63
		% within fatal rider or passenger	6.7%	7.8%	6.8%
	16:01 - 17:00	Frequency	52	12	64
		% within fatal rider or passenger	6.4%	11.7%	6.9%
	17:01 - 18:00	Frequency	81	8	89
		% within fatal rider or passenger	9.9%	7.8%	9.7%
	18:01 - 19:00	Frequency	68	9	77
		% within fatal rider or passenger	8.3%	8.7%	8.4%
	19:01 - 20:00	Frequency	60	13	73
		% within fatal rider or passenger	7.3%	12.6%	7.9%
	20:01 - 21:00	Frequency	27	5	32
		% within fatal rider or passenger	3.3%	4.9%	3.5%
	21:01 - 22:00	Frequency	22	4	26
		% within fatal rider or passenger	2.7%	3.9%	2.8%
	22:01 - 23:00	Frequency	27	2	29
		% within fatal rider or passenger	3.3%	1.9%	3.1%
	23:01 - 24:00	Frequency	8	2	10
		% within fatal rider or passenger	1.0%	1.9%	1.1%
Total		Frequency	818	103	921

	% within fatal rider or passenger	100.0%	100.0%	100.0%
--	-----------------------------------	--------	--------	--------

Table C.3: Month in which accident occurred

	Frequency	Percent
January	68	7.4
February	59	6.4
March	94	10.2
April	75	8.1
May	117	12.7
June	108	11.7
July	96	10.4
August	73	7.9
September	100	10.9
October	62	6.7
November	35	3.8
December	34	3.7
Total	921	100.0

Table C.4: PTW accident configuration by legal category

Frequency Row Percent Column Percent Total Percent	L1 vehicles		L3 vehicles		Total	
	Frequency	Percent of L1	Frequency	Percent of L3	Frequency	Percent
Head-on collision of PTW and OV (OV)	28	7.0	20	3.8	48	5.2
OV into PTW impact at intersection; paths perpendicular	37	9.3	21	4.0	58	6.3
PTW into OV impact at intersection; paths perpendicular	39	9.8	45	8.6	84	9.1
OV turning left in front of PTW, PTW perpendicular to OV path	35	8.8	47	9.0	82	8.9
OV turning right in front of PTW, PTW perpendicular to OV path	15	3.8	7	1.3	22	2.4
PTW and OV in opposite direction, OV turns in front of PTW, OV impacting PTW	14	3.5	10	1.9	24	2.6
PTW and OV travelling in opposite directions, OV turns in front of PTW, PTW impacting OV	24	6.0	55	10.5	79	8.6
PTW turning left in front of OV, OV proceeding in either direction perpendicular to PTW path	7	1.8	5	1.0	12	1.3
PTW turning right in front of OV, OV proceeding in either direction perpendicular to PTW path	0	0.0	2	0.4	2	0.2
PTW overtaking OV while OV turning left	25	6.3	31	5.9	56	6.1
PTW overtaking OV while OV turning right	8	2.0	3	0.6	11	1.2
OV impacting rear of PTW	12	3.0	8	1.5	20	2.2
PTW impacting rear of OV	24	6.0	35	6.7	59	6.4
Sideswipe, OV and PTW travelling in opposite directions	5	1.3	9	1.7	14	1.5
Sideswipe, OV and PTW travelling in same directions	12	3.0	16	3.1	28	3.0
OV making U-turn or Y-turn ahead of MV	12	3.0	27	5.2	39	4.2
Other PTW/OV impacts	44	11.1	29	5.5	73	7.9
PTW falling on roadway, no OV involvement	15	3.8	43	8.2	58	6.3
PTW running off roadway, no OV involvement	4	1.0	45	8.6	49	5.3
PTW falling on roadway in collision avoidance with OV	11	2.8	27	5.2	38	4.1
PTW running off roadway in collision avoidance with OV	0	0.0	5	1.0	5	0.5
Other PTW accidents with no OV or other involvement	0	0.0	3	0.6	3	0.3
PTW impacting pedestrian or animal	5	1.3	8	1.5	13	1.4
PTW impacting environmental object	13	3.3	11	2.1	24	2.6
Other	9	2.3	11	2.1	20	2.2
Total	398	100.0	523	100.0	921	100.0

Table C.5: Detailed primary accident contributing factors

	Frequency	Percent
PTW rider perception failure	110	12.0
PTW rider comprehension failure	33	3.6
PTW rider decision failure	120	13.0
PTW rider reaction failure	51	5.5
PTW rider other failure	27	2.9
Other vehicle driver perception failure	337	36.6
Other vehicle driver comprehension failure	13	1.4
Other vehicle driver decision failure	91	9.9
Other vehicle driver reaction failure	2	0.2
Other vehicle driver other failure	22	2.4
PTW technical failure	6	0.7
Environmental cause	72	7.7
Other human failure	37	4.1
Total	921	100.0

Table C.6: PTW style

	Accident data		Exposure data	
	Frequency	Percent	Frequency	Percent
Step-through	51	5.5	70	7.6
Scooter	354	38.4	349	37.7
Conventional street	131	14.2	117	12.7
Conventional street modified	25	2.7	8	0.9
Chopper	36	3.9	38	4.1
Enduro / Offroad	65	7.1	45	4.9
Sport Touring	76	8.3	110	11.9
Sport	137	14.9	126	13.7
Cruiser	37	4.0	51	5.5
Other	4	0.4	8	0.9
Unknown	5	0.5	1	0.1
Total	921	100.0	923	100.0

Table C.7: PTW style by legal category

	L1 vehicles		L3 vehicles		Total	
	Frequency	Percent of L1	Frequency	Percent of L3	Frequency	Percent
Step-through	51	12.8	0	0.0	51	5.5
Scooter	291	73.0	63	12.0	354	38.5
Conventional street	27	6.8	104	19.9	131	14.2
Conventional modified street	6	1.5	19	3.6	25	2.7
Chopper	0	0.0	36	6.9	36	3.9
Enduro / off-road	9	2.3	56	10.7	65	7.1
Sport Touring	0	0.0	76	14.5	76	8.3
Sport	11	2.8	126	24.1	137	14.9
Cruiser	0	0.0	37	7.1	37	4.0
Other	1	0.3	3	0.6	4	0.4
Unknown	2	0.5	3	0.6	5	0.5
Total	398	100.0	523	100.0	921	100.0

Table C.8: Comparison of travelling speed for fatal and non fatal cases (all accidents)

			Fatal rider or passenger		Total
			non fatal	fatal	
PTW travelling speed (km/h)	<= 0	Count	18	0	18
		% within fatal rider or passenger	2.2%	0.0%	2.0%
	1 - 10	Count	21	0	21
		% within fatal rider or passenger	2.6%	0.0%	2.3%
	11 - 20	Count	35	0	35
		% within fatal rider or passenger	4.3%	0.0%	3.8%
	21 - 30	Count	106	4	110
		% within fatal rider or passenger	13.0%	3.9%	12.0%
	31 - 40	Count	150	6	156
		% within fatal rider or passenger	18.4%	5.8%	17.0%
	41 - 50	Count	166	10	176
		% within fatal rider or passenger	20.4%	9.7%	19.2%
	51 - 60	Count	115	12	127
		% within fatal rider or passenger	14.1%	11.7%	13.8%
	61 - 70	Count	64	10	74
		% within fatal rider or passenger	7.9%	9.7%	8.1%
	71 - 80	Count	48	16	64
		% within fatal rider or passenger	5.9%	15.5%	7.0%
	81 - 90	Count	34	12	46
		% within fatal rider or passenger	4.2%	11.7%	5.0%
	91 - 100	Count	20	6	26
		% within fatal rider or passenger	2.5%	5.8%	2.8%
	101 - 110	Count	16	6	22
		% within fatal rider or passenger	2.0%	5.8%	2.4%
	111 - 120	Count	8	7	15
		% within fatal rider or passenger	1.0%	6.8%	1.6%
	121 - 130	Count	5	4	9
		% within fatal rider or passenger	0.6%	3.9%	1.0%
	131 - 140	Count	5	3	8
		% within fatal rider or passenger	0.6%	2.9%	0.9%
	141 - 150	Count	2	2	4
		% within fatal rider or passenger	0.2%	1.9%	0.4%
151 - 160	Count	1	4	5	
	% within fatal rider or passenger	0.1%	3.9%	0.5%	
161 - 170	Count	0	1	1	
	% within fatal rider or passenger	0.0%	1.0%	0.1%	
171+	Count	1	0	1	
	% within fatal rider or passenger	0.1%	0.0%	0.1%	
Total		Count	815	103	918
		% within fatal rider or passenger	100.0%	100.0%	100.0%

Table C.9: Roadside barrier injury summary

Frequency Row Percent Column Percent Total Percent	AIS						Total
	Minor	Moderate	Serious	Severe	Critical	Maximum	
Head	0	3	1	5	1	2	12
	0.0%	25.0%	8.3%	41.7%	8.3%	16.7%	100.0%
	0.0%	15.0%	11.1%	83.3%	50.0%	100.0%	20.0%
	0.0%	5.0%	1.7%	8.3%	1.7%	3.3%	20.0%
Neck	1	0	0	0	0	0	1
	100.0%	0.0%	0.0%	0.0%	0.0%	0.0%	100.0%
	4.8%	0.0%	0.0%	0.0%	0.0%	0.0%	1.7%
	1.7%	0.0%	0.0%	0.0%	0.0%	0.0%	1.7%
Upper extremities	3	0	1	1	1	0	6
	50.0%	0.0%	16.7%	16.7%	16.7%	0.0%	100.0%
	14.3%	0.0%	11.1%	16.7%	50.0%	0.0%	10.0%
	5.0%	0.0%	1.7%	1.7%	1.7%	0.0%	10.0%
Abdomen	0	7	1	0	0	0	8
	0.0%	87.5%	12.5%	0.0%	0.0%	0.0%	100.0%
	0.0%	35.0%	11.1%	0.0%	0.0%	0.0%	13.3%
	0.0%	11.7%	1.7%	0.0%	0.0%	0.0%	13.3%
Pelvis	1	1	0	0	0	0	2
	50.0%	50.0%	0.0%	0.0%	0.0%	0.0%	100.0%
	4.8%	5.0%	0.0%	0.0%	0.0%	0.0%	3.3%
	1.7%	1.7%	0.0%	0.0%	0.0%	0.0%	3.3%
Spine	8	7	1	0	0	0	16
	50.0%	43.8%	6.3%	0.0%	0.0%	0.0%	100.0%
	38.1%	35.0%	11.1%	0.0%	0.0%	0.0%	26.7%
	13.3%	11.7%	1.7%	0.0%	0.0%	0.0%	26.7%
Lower extremities	7	2	5	0	0	0	14
	50.0%	14.3%	35.7%	0.0%	0.0%	0.0%	100.0%
	33.3%	10.0%	55.6%	0.0%	0.0%	0.0%	23.3%
	11.7%	3.3%	8.3%	0.0%	0.0%	0.0%	23.3%
Whole body	1	0	0	0	0	0	1
	100.0%	0.0%	0.0%	0.0%	0.0%	0.0%	100.0%
	4.8%	0.0%	0.0%	0.0%	0.0%	0.0%	1.7%
	1.7%	0.0%	0.0%	0.0%	0.0%	0.0%	1.7%
Totals	21	20	9	6	2	2	60
	35.0%	33.3%	15.0%	10.0%	3.3%	3.3%	100.0%
	100.0%	100.0%	100.0%	100.0%	100.0%	100.0%	100.0%
	100.0%	100.0%	100.0%	100.0%	100.0%	100.0%	100.0%

Table C.10: PTW rider age

	Accident data		Exposure data	
	Frequency	Percent	Frequency	Percent
up to 15	29	3.1	30	3.3
16-17	126	13.7	119	12.9
18-21	142	15.5	100	10.8
22-25	132	14.3	84	9.1
26-40	331	36.0	352	38.1
41-55	134	14.5	190	20.6
>56	25	2.7	48	5.2
Unknown	2	0.2	0	0.0
Total	921	100.0	923	100.0

Table C.11: PTW rider age by PTW legal category

	L1 vehicles		L3 vehicles		Total	
	Frequency	Percent of L1	Frequency	Percent of L3	Frequency	Percent
Up to 15	28	7.0	1	0.2	29	3.1
16-17	102	25.6	24	4.6	126	13.7
18-21	104	26.1	38	7.3	142	15.4
22-25	42	10.6	90	17.2	132	14.3
26-40	68	17.1	263	50.3	331	35.9
41-55	40	10.1	94	18.0	134	14.5
>56	13	3.3	12	2.3	25	2.7
Unknown	1	0.2	1	0.2	2	0.2
Total	398	100.0	523	100.0	921	100.0

Table C.12: Cross-tabulation of PTW rider age by primary accident contributing factor

Frequency Row Percent Column Percent Total Percent		Primary accident contributing factor					Total
		PTW rider	OV driver	PTW technical failure	Environmental cause	Other	
PTW rider age	up to 15	12	16	0	1	0	29
		41.4%	55.2%	0.0%	3.4%	0.0%	100.0%
		3.5%	3.4%	0.0%	1.4%	0.0%	3.2%
		1.3%	1.7%	0.0%	0.1%	0.0%	3.2%
	16-17	54	51	1	15	5	126
		42.9%	40.5%	0.8%	11.9%	4.0%	100.0%
		15.9%	11.0%	16.7%	21.1%	13.2%	13.7%
		5.9%	5.6%	0.1%	1.6%	0.5%	13.7%
	18-21	59	66	2	7	8	142
		41.5%	46.5%	1.4%	4.9%	5.6%	100.0%
		17.4%	14.2%	33.3%	9.9%	21.1%	15.5%
		6.4%	7.2%	0.2%	0.8%	0.9%	15.5%
	22-25	48	69	1	7	7	132
		36.4%	52.3%	0.8%	5.3%	5.3%	100.0%
		14.2%	14.9%	16.7%	9.9%	18.4%	14.4%
		5.2%	7.5%	0.1%	0.8%	0.8%	14.4%
	26-40	117	180	2	20	12	331
		35.3%	54.4%	0.6%	6.0%	3.6%	100.0%
		34.5%	38.8%	33.3%	28.2%	31.6%	36.1%
		12.7%	19.6%	0.2%	2.2%	1.3%	36.1%
	41-55	40	70	0	19	5	134
		30.1%	51.9%	0.0%	14.3%	3.8%	100.0%
		11.8%	14.9%	0.0%	26.8%	13.2%	14.5%
		4.4%	7.5%	0.0%	2.1%	0.5%	14.5%
	>56	9	13	0	2	1	25
		36.0%	52.0%	0.0%	8.0%	4.0%	100.0%
		2.7%	2.8%	0.0%	2.8%	2.6%	2.7%
		1.0%	1.4%	0.0%	0.2%	0.1%	2.7%
Total	339	464	6	71	38	919	
	36.9%	50.5%	0.7%	7.7%	4.1%	100.0%	
	100.0%	100.0%	100.0%	100.0%	100.0%	100.0%	
	36.9%	50.5%	0.7%	7.7%	4.1%	100.0%	

Note: There were 2 cases in which the age of the rider was not known.

Table C.13: PTW rider age by primary accident contributing factor (L1 vehicles)

Frequency Row Percent Column Percent Total Percent		PTW rider	OV driver	PTW technical failure	Environmental cause	Other	Total
PTW rider age	Up to 15	11	16	0	1	0	28
		39.3%	57.1%	0.0%	3.6%	0.0%	100.0%
		7.1%	8.0%	0.0%	3.2%	0.0%	7.0%
		2.8%	4.0%	0.0%	0.3%	0.0%	7.0%
	16 to 17	44	42	1	11	4	102
		43.1%	41.2%	1.0%	10.8%	3.9%	100.0%
		28.4%	21.1%	50.0%	35.5%	36.4%	25.6%
		11.1%	10.6%	0.3%	2.8%	1.0%	25.6%
	18 to 21	47	50	1	3	3	104
		45.2%	48.1%	1.0%	2.9%	2.9%	100.0%
		30.3%	25.1%	50.0%	9.7%	27.3%	26.1%
		11.8%	12.6%	0.3%	0.8%	0.8%	26.1%
	22 to 25	14	25	0	1	2	42
		33.3%	59.5%	0.0%	2.4%	4.8%	100.0%
		9.0%	12.6%	0.0%	3.2%	18.2%	10.6%
		3.5%	6.3%	0.0%	0.3%	0.5%	10.6%
	26 to 40	21	41	0	6	0	68
		30.9%	60.3%	0.0%	8.8%	0.0%	100.0%
		13.5%	20.6%	0.0%	19.4%	0.0%	17.1%
		5.3%	10.3%	0.0%	1.5%	0.0%	17.1%
	41 to 55	11	18	0	9	2	40
		27.5%	45.0%	0.0%	22.5%	5.0%	100.0%
		7.1%	9.0%	0.0%	29.0%	18.2%	10.1%
		2.8%	4.5%	0.0%	2.3%	0.5%	10.1%
	> 56	6	7	0	0	0	13
		46.2%	53.8%	0.0%	0.0%	0.0%	100.0%
		3.9%	3.5%	0.0%	0.0%	0.0%	3.3%
		1.5%	1.8%	0.0%	0.0%	0.0%	3.3%
Unknown	1	0	0	0	0	1	
	100.0%	0.0%	0.0%	0.0%	0.0%	100.0%	
	0.6%	0.0%	0.0%	0.0%	0.0%	0.3%	
	0.3%	0.0%	0.0%	0.0%	0.0%	0.3%	
Total	155	199	2	31	11	398	
	38.9%	50.0%	0.5%	7.8%	2.8%	100.0%	
	100.0%	100.0%	100.0%	100.0%	100.0%	100.0%	
	38.9%	50.0%	0.5%	7.8%	2.8%	100.0%	

Table C.14: PTW rider age by primary accident contributing factor (L3 vehicles)

Frequency Row Percent Column Percent Total Percent		PTW rider	OV driver	PTW technical failure	Environmental cause	Other	Unknown	Total
PTW rider age	up to 15	1	0	0	0	0	0	1
		100.0%	0.0%	0.0%	0.0%	0.0%	0.0%	100.0%
		0.5%	0.0%	0.0%	0.0%	0.0%	0.0%	0.2%
		0.2%	0.0%	0.0%	0.0%	0.0%	0.0%	0.2%
	16 to 17	10	9	0	4	1	0	24
		41.7%	37.5%	0.0%	16.7%	4.2%	0.0%	100.0%
		5.4%	3.4%	0.0%	10.0%	3.7%	0.0%	4.6%
		1.9%	1.7%	0.0%	0.8%	0.2%	0.0%	4.6%
	18 to 21	12	16	1	4	5	0	38
		31.6%	42.1%	2.6%	10.5%	13.2%	0.0%	100.0%
		6.5%	6.0%	25.0%	10.0%	18.5%	0.0%	7.3%
		2.3%	3.1%	0.2%	0.8%	1.0%	0.0%	7.3%
	22 to 25	34	44	1	6	5	0	90
		37.8%	48.9%	1.1%	6.7%	5.6%	0.0%	100.0%
		18.3%	16.6%	25.0%	15.0%	18.5%	0.0%	17.2%
		6.5%	8.4%	0.2%	1.1%	1.0%	0.0%	17.2%
	26 to 40	96	139	2	14	12	0	263
		36.5%	52.9%	0.8%	5.3%	4.6%	0.0%	100.0%
		51.6%	52.5%	50.0%	35.0%	44.4%	0.0%	50.3%
		18.4%	26.6%	0.4%	2.7%	2.3%	0.0%	50.3%
	41 to 55	29	51	0	10	3	1	94
		30.9%	54.3%	0.0%	10.6%	3.2%	1.1%	100.0%
		15.6%	19.2%	0.0%	25.0%	11.1%	100%	18.0%
		5.5%	9.8%	0.0%	1.9%	0.6%	0.2%	18.0%
	> 56	3	6	0	2	1	0	12
		25.0%	50.0%	0.0%	16.7%	8.3%	0.0%	100.0%
		1.6%	2.3%	0.0%	5.0%	3.7%	0.0%	2.3%
		0.6%	1.1%	0.0%	.4%	0.2%	0.0%	2.3%
	Unknown	1	0	0	0	0	0	1
		100.0%	0.0%	0.0%	.0%	0.0%	0.0%	100.0%
0.5%		0.0%	0.0%	.0%	0.0%	0.0%	0.2%	
0.2%		0.0%	0.0%	.0%	0.0%	0.0%	0.2%	
Total	186	265	4	40	27	1	523	
	35.6%	50.7%	0.8%	7.6%	5.2%	0.2%	100.0%	
	100.0%	100.0%	100.0%	100.0	100.0%	100.0%	100.0%	
	35.6%	50.7%	0.8%	7.6%	5.2%	0.2%	100.0%	

Table C.15: PTW travelling speed by PTW rider age

Frequency Row Percent Column Percent Total Percent		PTW rider age						Total	
		Up to 15	16-17	18-21	22-25	26-40	41-55		>55
TW Travelling speed	0 - 30 km/h	9	28	30	22	56	27	11	183
		4.9%	15.3%	16.4%	12.0%	30.6%	14.8%	6.0%	100.0%
		31.0%	22.4%	21.3%	16.8%	16.9%	20.1%	44.0%	20.0%
		1.0%	3.1%	3.3%	2.4%	6.1%	2.9%	1.2%	20.0%
	31 - 50 km/h	14	58	63	52	91	47	7	332
		4.2%	17.5%	19.0%	15.7%	27.4%	14.2%	2.1%	100.0%
		48.3%	46.4%	44.7%	39.7%	27.5%	35.1%	28.0%	36.2%
		1.5%	6.3%	6.9%	5.7%	9.9%	5.1%	0.8%	36.2%
	51- 60 km/h	4	24	20	13	43	19	4	127
		3.1%	18.9%	15.7%	10.2%	33.9%	15.0%	3.1%	100.0%
		13.8%	19.2%	14.2%	9.9%	13.0%	14.2%	16.0%	13.9%
		0.4%	2.6%	2.2%	1.4%	4.7%	2.1%	0.4%	13.9%
	>60 km/h	2	15	28	44	141	41	3	274
		0.7%	5.5%	10.2%	16.1%	51.5%	15.0%	1.1%	100.0%
		6.9%	12.0%	19.9%	33.6%	42.6%	30.6%	12.0%	29.9%
		0.2%	1.6%	3.1%	4.8%	15.4%	4.5%	0.3%	29.9%
Total	29	125	141	131	331	134	25	916	
	3.2%	13.6%	15.4%	14.3%	36.1%	14.6%	2.7%	100.0%	
	100.0%	100.0%	100.0%	100.0%	100.0%	100.0%	100.0%	100.0%	
	3.2%	13.6%	15.4%	14.3%	36.10%	14.6%	2.7%	100.0%	

Note: There were 2 cases in which the age of the rider was not known and 3 cases in which the travelling speed was not known.

Table C.16: PTW impact speed by PTW rider age

Frequency Row Percent Column Percent Total Percent		PTW rider age							Total
		Up to 15	16-17	18-21	22-25	26-40	41-55	>55	
PTW impact speed	0 – 30 km/h	11	49	52	44	93	50	13	312
		3.5%	15.7%	16.7%	14.1%	29.8%	16.0%	4.2%	100.0%
		37.9%	39.2%	36.6%	33.6%	28.1%	37.3%	52.0%	34.0%
		1.2%	5.3%	5.7%	4.8%	10.1%	5.5%	1.4%	34.0%
	31 - 50 km/h	13	51	59	45	110	42	10	330
		3.9%	15.5%	17.9%	13.6%	33.3%	12.7%	3.0%	100.0%
		44.8%	40.8%	41.5%	34.4%	33.2%	31.3%	40.0%	36.0%
		1.4%	5.6%	6.4%	4.9%	12.0%	4.6%	1.1%	36.0%
	51- 60 km/h	3	16	14	13	30	18	1	95
		3.2%	16.8%	14.7%	13.7%	31.6%	18.9%	1.1%	100.0%
		10.3%	12.8%	9.9%	9.9%	9.1%	13.4%	4.0%	10.4%
		0.3%	1.7%	1.5%	1.4%	3.3%	2.0%	0.1%	10.4%
	>60 km/h	2	9	17	29	98	24	1	180
		1.1%	5.0%	9.4%	16.1%	54.4%	13.3%	0.6%	100.0%
		6.9%	7.2%	12.0%	22.1%	29.6%	17.9%	4.0%	19.6%
		0.2%	1.0%	1.9%	3.2%	10.7%	2.6%	0.1%	19.6%
Total	29	125	142	131	331	134	25	917	
	3.2%	13.6%	15.5%	14.3%	36.1%	14.6%	2.7%	100.0%	
	100.0%	100.0%	100.0%	100.0%	100.0%	100.0%	100.0%	100.0%	
	3.2%	13.6%	15.5%	14.3%	36.1%	14.6%	2.7%	100.0%	

Note: There were 2 cases in which the age of the rider was not known and 2 cases in which the PTW impact speed was not known.

Table C.17: Cross-tabulation of primary accident contributing factor by OV driver's licence qualification

Frequency Row Percent Column Percent Total Percent		OV driver's licence qualification					Total
		None	Car licence	PTW licence	Only licence for OVs other than PTW and car	Not required	
Detailed primary accident contributing factor	PTW rider perception failure	0	52	20	8	2	82
		0.0%	53.4%	24.4%	9.8%	2.4%	100.0%
		0.0%	10.0%	12.3%	17.0%	25.0%	11.0%
		0.0%	7.0%	2.7%	1.1%	0.3%	11.0%
	PTW rider comprehension failure	0	14	8	3	0	25
		0.0%	56.0%	32.0%	12.0%	0.0%	100.0%
		0.0%	2.7%	4.9%	5.4%	0.0%	3.4%
		0.0%	1.9%	1.1%	0.4%	0.0%	3.4%
	PTW rider decision failure	1	56	28	11	0	96
		1.0%	58.3%	29.2%	11.5%	0.0%	100.0%
		16.7%	10.8%	17.2%	23.4%	0.0%	12.9%
		0.1%	7.5%	3.8%	1.5%	0.0%	12.9%
	PTW rider reaction failure	0	17	7	4	1	29
		0.0%	58.6%	24.1%	13.8%	3.4%	100.0%
		0.0%	3.3%	4.3%	8.5%	12.5%	3.9%
		0.0%	2.3%	0.9%	0.5%	0.1%	3.9%
	PTW rider other failure	0	3	2	0	0	5
		0.0%	60.0%	40.0%	0.0%	0.0%	100.0%
		0.0%	0.6%	1.2%	0.0%	0.0%	0.7%
		0.0%	0.4%	0.3%	0.0%	0.0%	0.7%
	ov driver perception failure	2	264	43	12	4	325
		0.6%	81.2%	13.2%	3.7%	1.2%	100.0%
		33.3%	50.9%	26.4%	25.5%	50.0%	43.7%
		0.3%	35.5%	5.8%	1.6%	0.5%	43.7%
	ov driver comprehension failure	0	8	4	1	0	13
		0.0%	61.5%	30.8%	7.7%	0.0%	100.0%
		0.0%	1.5%	2.5%	2.1%	0.0%	1.7%
		0.0%	1.1%	0.5%	0.1%	0.0%	1.7%
	ov driver decision failure	1	56	21	7	0	85
		1.2%	65.9%	24.7%	8.2%	0.0%	100.0%
		16.7%	10.8%	12.9%	14.9%	0.0%	11.4%
		0.1%	7.5%	2.8%	0.9%	0.0%	11.4%
	ov driver reaction failure	0	1	1	0	0	2
		0.0%	50.0%	50.0%	0.0%	0.0%	100.0%
		0.0%	0.2%	0.6%	0.0%	0.0%	0.3%
		0.0%	0.1%	0.1%	0.0%	0.0%	0.3%
	ov driver other failure	1	12	3	0	0	16
		6.3%	75.0%	18.8%	0.0%	0.0%	100.0%
		16.7%	2.3%	1.8%	0.0%	0.0%	2.2%
		0.1%	1.6%	0.4%	0.0%	0.0%	2.2%
	PTW technical failure	0	0	1	0	0	1
		0.0%	0.0%	100.0%	0.0%	0.0%	100.0%
		0.0%	0.0%	0.6%	0.0%	0.0%	0.1%
		0.0%	0.0%	0.1%	0.0%	0.0%	0.1%
Environmental cause	1	24	16	1	1	43	
	2.3%	55.8%	37.2%	2.3%	2.3%	100.0%	
	16.7%	4.6%	9.8%	2.1%	12.5%	5.8%	
	0.1%	3.2%	2.2%	0.1%	0.1%	5.8%	
Other	0	12	9	0	0	21	
	0.0%	57.1%	42.9%	0.0%	0.0%	100.0%	
	0.0%	2.3%	5.5%	0.0%	0.0%	2.8%	
	0.0%	1.6%	1.2%	0.0%	0.0%	2.8%	
Total	6	519	163	47	8	743	
	0.8%	69.9%	21.9%	6.3%	1.1%	100.0%	
	100.0%	100.0%	100.0%	100.0%	100.0%	100.0%	
	0.8%	69.9%	21.9%	6.3%	1.1%	100.0%	

Note: There were 35 cases in which the OV driver qualification was not known.

Table C.18: Riding experience on any PTW

	Accident data		Exposure data	
	Frequency	Percent	Frequency	Percent
up to 6	72	7.8	48	5.2
7 to 12	79	8.6	78	8.5
13 to 36	173	18.7	183	19.7
37 to 60	91	9.9	92	10.0
61 to 97	68	7.4	79	8.6
98 or more	221	24.0	431	46.7
Unknown	217	23.6	12	1.3
Total	921	100.0	923	100.0

Table C.19: Riding experience on vehicle in use at time of accident or exposure survey

	Accident data		Exposure data	
	Frequency	Percent	Frequency	Percent
up to 6	223	24.2	211	22.9
7 to 12	150	16.3	186	20.2
13 to 36	226	24.6	319	34.5
37 to 60	50	5.4	76	8.2
61 to 97	28	3.0	56	6.1
98 or more	21	2.3	65	7.0
Unknown	223	24.2	10	1.1
Total	921	100.0	923	100.0

Table C.20: Rider experience on accident PTW

	L1 vehicles		L3 vehicles		Total	
	Frequency	Percent of L1	Frequency	Percent of L3	Frequency	Percent
Up to 6	86	21.6	137	26.2	223	24.2
7 to 12	73	18.3	77	14.6	150	16.3
13 to 36	97	24.4	129	24.7	226	24.6
37 to 60	24	6.0	26	5.0	50	5.4
61 to 97	11	2.8	17	3.3	28	3.0
98 or more	5	1.3	16	3.1	21	2.3
Unknown	102	25.6	121	23.1	223	24.2
Total	398	100.0	523	100.0	921	100.0

Table C.21: PTW rider experience on any PTW

	L1 vehicles		L3 vehicles		Total	
	Frequency	Percent	Frequency	Percent	Frequency	Percent
up to 6	28	7.0	44	8.4	72	7.8
7 to 12	48	12.1	31	5.9	79	8.5
13 to 36	99	24.8	74	14.1	173	18.9
37 to 60	50	12.6	41	7.8	91	9.9
61 to 97	23	5.8	45	8.6	68	7.4
98 or more	60	15.1	161	30.9	221	24.0
Unknown	90	22.6	127	24.3	217	23.5
Total	398	100.0	523	100.0	921	100.0

Table C.22: Cross-tabulation of primary accident contributing factor by riding experience on any PTW

Frequency Row Percent Column Percent Total Percent		Riding experience on any PTW (months)						Total
		up to 6	7 to 12	13 to 36	37 to 60	61 to 97	98 or more	
Primary accident contributing factor	PTW rider	34	29	63	30	19	70	245
		13.9%	11.8%	25.7%	12.2%	7.8%	28.6%	100.0%
		47.2%	36.7%	36.4%	33.0%	27.9%	31.7%	34.8%
		4.8%	4.1%	8.9%	4.3%	2.7%	9.9%	34.8%
	OV driver	26	42	88	44	37	128	365
		7.1%	11.5%	24.1%	12.1%	10.1%	35.1%	100.0%
		36.1%	53.2%	50.9%	48.4%	54.4%	57.9%	51.8%
		3.7%	6.0%	12.5%	6.3%	5.3%	18.2%	51.8%
	PTW technical failure	0	0	0	2	0	1	3
		0.0%	0.0%	0.0%	66.7%	0.0%	33.3%	100.0%
		0.0%	0.0%	0.0%	2.2%	0.0%	0.5%	0.4%
	Environmental cause	6	6	18	8	7	16	61
		9.8%	9.8%	29.5%	13.1%	11.5%	26.2%	100.0%
		8.3%	7.6%	10.4%	8.8%	10.3%	7.2%	8.7%
	Other	6	2	4	7	5	6	30
		20.0%	6.7%	13.3%	23.3%	16.7%	20.0%	100.0%
		8.3%	2.5%	2.3%	7.7%	7.4%	2.7%	4.3%
	Total	72	79	173	91	68	221	704
		10.2%	11.2%	24.6%	12.9%	9.7%	31.4%	100.0%
		100.0%	100.0%	100.0%	100.0%	100.0%	100.0%	100.0%
		10.2%	11.2%	24.6%	12.9%	9.7%	31.4%	100.0%

Note: There were 217 cases in which the PTW riding experience was not known.

Table C.23: PTW collision avoidance manoeuvre by PTW training

Frequency Row Percent		PTW training				Total
		None	Compulsory training	Additional training	Unknown	
PTW collision avoidance manoeuvre	None	174	151	1	36	362
		48.1%	41.7%	0.3%	9.9%	100.0%
		47.2%	33.2%	25.0%	38.7%	39.6%
		18.9%	16.4%	0.1%	3.9%	39.6%
	Braking, other	97	171	0	31	299
		32.4%	57.2%	0.0%	10.4%	100.0%
		26.3%	37.6%	0.0%	33.3%	32.5%
		10.5%	18.6%	0.0%	3.4%	32.5%
	Swerve, other	24	34	1	5	64
		37.5%	53.1%	1.6%	7.8%	100.0%
		6.5%	7.5%	25.0%	5.4%	7.0%
		2.6%	3.7%	0.1%	0.5%	7.0%
	Braking and swerve, other	65	71	1	16	153
		42.5%	46.4%	0.7%	10.5%	100.0%
		17.6%	15.6%	25.0%	17.2%	16.6%
		7.1%	7.7%	0.1%	1.7%	16.6%
	Other only	7	26	1	2	36
		19.4%	72.2%	2.8%	5.6%	100.0%
		1.9%	5.7%	25.0%	2.2%	3.9%
		0.8%	2.8%	0.1%	0.2%	3.9%
Unknown	2	2	0	3	7	
	28.6%	28.6%	0.0%	42.9%	100.0%	
	0.5%	0.4%	0.0%	3.2%	0.8%	
	0.2%	0.2%	0.0%	0.3%	0.8%	
Total	369	455	4	93	921	
	44.5%	55.0%	0.5%	10.1%	100.0%	
	100.0%	100.0%	100.0%	100.0%	100.0%	
	44.5%	55.0%	0.5%	10.1%	100.0%	

Table C.24: Cross-tabulation of PTW rider experience by identification of skill deficiency as a contributing factor

Frequency Row Percent Column Percent Total Percent		PTW skill deficiency as contributing factor for accident		Total
		Yes	No	
Riding experience on any PTW (months)	up to 6	20	49	69
		29.0%	71.0%	100.0%
		30.3%	7.8%	9.9%
		2.9%	7.0%	9.9%
	7 to 12	8	71	79
		10.1%	89.9%	100.0%
		12.1%	11.3%	11.3%
		1.1%	10.2%	11.3%
	13 to 36	14	157	171
		8.2%	91.8%	100.0%
		21.2%	24.9%	24.5%
		2.0%	22.5%	24.5%
	37 to 60	6	84	90
		6.7%	93.3%	100.0%
		9.1%	13.3%	12.9%
		0.9%	12.1%	12.9%
	61 to 97	4	64	68
		5.9%	94.1%	100.0%
		6.1%	10.1%	9.8%
		0.6%	9.2%	9.8%
98 or more	14	206	220	
	6.4%	93.6%	100.0%	
	21.2%	32.6%	31.6%	
	2.0%	29.6%	31.6%	
Total	66	631	697	
	9.5%	90.5%	100.0%	
	100.0%	100.0%	100.0%	
	9.5%	90.5%	100.0%	

Note: There were 26 cases in which the PTW riding experience was not known.

Table C.25: PTW first collision contact code

	Frequency	Percent
Centre front	266	28.9
Centre rear	18	2.0
Left centre	116	12.6
Left front	152	16.5
Left rear	26	2.8
No direct contact to PTW	6	0.7
Right centre	120	13.1
Right front	156	16.9
Right rear	13	1.4
Top centre	3	0.3
Top front	18	2.0
Top rear	1	0.1
Undercarriage centre	4	0.4
Undercarriage front	9	1.0
Undercarriage rear	4	0.4
Other	5	0.5
Unknown	4	0.4
Total	921	100.0

Table C.26: OV first collision contact code

	Frequency	Percent
Vehicle Front Left	111	14.3
Vehicle Side Left	170	21.9
Vehicle Rear Left	27	3.5
Vehicle Undercarriage Left	3	0.4
Vehicle Front Right	80	10.3
Vehicle Side Right	141	18.2
Vehicle Rear Right	26	3.3
Vehicle Front Centre	56	7.2
Vehicle Rear Centre	18	2.3
PTW Left Front	14	1.8
PTW Centre Front	14	1.8
PTW Right Front	13	1.7
PTW Undercarriage Front	1	0.1
PTW Left Centre	9	1.2
PTW Right Centre	4	0.5
PTW Left Rear	6	0.8
OV present, no contact	33	4.2
Other	5	0.6
Unknown	47	5.9
Total	778	100.0

Table C.27: Distribution of injuries to PTW riders and passengers

	PTW rider		PTW passenger		Total	
	Frequency	Percent	Frequency	Percent	Frequency	Percent
	628	18.4	55	24.2	683	18.7
Neck	38	1.1	0	0.0	38	1.0
Thorax	254	7.4	8	3.5	262	7.2
Upper extremities	830	24.3	41	18.1	871	23.9
Abdomen	140	4.1	7	3.1	147	4.0
Spine	171	5.0	10	4.4	181	5.0
Pelvis	75	2.2	3	1.3	78	2.1
Lower extremities	1086	31.8	73	32.2	1159	31.8
Whole body	195	5.7	30	13.2	225	6.2
Total	3417	100.0	227	100.0	3644	100.0

Table C.28: Cross-tabulation of rider MAIS by body region

Frequency Row Percent Column Percent Total Percent		AIS injury severity					Unknown	Total	
		Minor	Moderate	Serious	Severe	Critical			Maximum
Body region	HEAD	112	148	46	1	33	7	22	395
		28.4%	37.5%	11.6%	0.3%	8.4%	1.8%	5.6%	100.0%
		10.4%	24.4%	15.9%	2.2%	52.4%	26.9%	18.8%	17.7%
		5.0%	6.6%	2.1%	0.0%	1.5%	0.3%	1.0%	17.7%
	NECK	26	6	1	0	0	1	4	38
		68.4%	15.8%	2.6%	0.0%	0.0%	2.6%	10.5%	100.0%
		2.4%	1.0%	0.3%	0.0%	0.0%	3.8%	3.4%	1.7%
		1.2%	0.3%	0.0%	0.0%	0.0%	0.0%	0.2%	1.7%
	THORAX	79	20	32	33	9	7	16	196
		40.3%	10.2%	16.3%	16.8%	4.6%	3.6%	8.2%	100.0%
		7.3%	3.3%	11.0%	71.7%	14.3%	26.9%	13.7%	8.8%
		3.5%	0.9%	1.4%	1.5%	0.4%	0.3%	0.7%	8.8%
	UPPER EX	264	206	39	0	0	0	6	515
		51.3%	40.0%	7.6%	0.0%	0.0%	0.0%	1.2%	100.0%
		24.5%	34.0%	13.4%	0.0%	0.0%	0.0%	5.1%	23.1%
		11.9%	9.3%	1.8%	0.0%	0.0%	0.0%	0.3%	23.1%
	ABDOMEN	48	15	13	5	11	1	15	108
		44.4%	13.9%	12.0%	4.6%	10.2%	0.9%	13.9%	100.0%
		4.4%	2.5%	4.5%	10.9%	17.5%	3.8%	12.8%	4.8%
		2.2%	0.7%	0.6%	0.2%	0.5%	0.0%	0.7%	4.8%
	SPINE	58	30	5	1	8	10	12	124
		46.8%	24.2%	4.0%	0.8%	6.5%	8.1%	9.7%	100.0%
		5.4%	5.0%	1.7%	2.2%	12.7%	38.5%	10.3%	5.6%
		2.6%	1.3%	0.2%	0.0%	0.4%	0.4%	0.5%	5.6%
	PELVIS	24	23	11	3	0	0	8	69
		34.8%	33.3%	15.9%	4.3%	0.0%	0.0%	11.6%	100.0%
		2.2%	3.8%	3.8%	6.5%	0.0%	0.0%	6.8%	3.1%
		1.1%	1.0%	0.5%	0.1%	0.0%	0.0%	0.4%	3.1%
	LOWER EX	364	158	143	3	2	0	11	681
		53.5%	23.2%	21.0%	0.4%	0.3%	0.0%	1.6%	100.0%
		33.7%	26.1%	49.3%	6.5%	3.2%	0.0%	9.4%	30.6%
		16.3%	7.1%	6.4%	0.1%	0.1%	0.0%	0.5%	30.6%
	WHOLE BODY	104	0	0	0	0	0	23	127
		81.9%	0.0%	0.0%	0.0%	0.0%	0.0%	18.1%	100.0%
		9.6%	0.0%	0.0%	0.0%	0.0%	0.0%	19.7%	5.7%
		4.7%	0.0%	0.0%	0.0%	0.0%	0.0%	1.0%	5.7%
Total	1079	606	290	46	63	26	117	2227	
	48.5%	27.2%	13.0%	2.1%	2.8%	1.2%	5.3%	100.0%	
	100.0%	100.0%	100.0%	100.0%	100.0%	100.0%	100.0%	100.0%	
	48.5%	27.2%	13.0%	2.1%	2.8%	1.2%	5.3%	100.0%	

Table C.29: Distribution of rider head MAIS by collision contact code

Frequency Row Percent Column Percent Total Percent		OV	PTW	Road/ roadside	Helmet	Animal or pedestrian	Unknown	Total
Rider's head MAIS	Minor	33	5	55	13	0	6	112
		29.5%	4.5%	49.1%	11.6%	0.0%	5.4%	100.0%
		24.8%	27.8%	28.9%	50.0%	0.0%	23.1%	28.4%
		8.4%	1.3%	13.9%	3.3%	0.0%	1.5%	28.4%
	Moderate	39	10	77	11	2	9	148
		26.4%	6.8%	52.0%	7.4%	1.4%	6.1%	100.0%
		29.3%	55.6%	40.5%	42.3%	100.0%	34.6%	37.5%
		9.9%	2.5%	19.5%	2.8%	0.5%	2.3%	37.5%
	Serious	28	2	14	1	0	1	46
		60.9%	4.3%	30.4%	2.2%	0.0%	2.2%	100.0%
		21.1%	11.1%	7.4%	3.8%	0.0%	3.8%	11.6%
		7.1%	0.5%	3.5%	0.3%	0.0%	0.3%	11.6%
	Severe	14	1	11	0	0	1	27
		51.9%	3.7%	40.7%	0.0%	0.0%	3.7%	100.0%
		10.5%	5.6%	5.8%	0.0%	0.0%	3.8%	6.8%
		3.5%	0.3%	2.8%	0.0%	0.0%	0.3%	6.8%
	Critical	11	0	21	0	0	1	33
		33.3%	0.0%	63.6%	0.0%	0.0%	3.0%	100.0%
		8.3%	0.0%	11.1%	0.0%	0.0%	3.8%	8.4%
		2.8%	0.0%	5.3%	0.0%	0.0%	0.3%	8.4%
	Maximum	5	0	2	0	0	0	7
		71.4%	0.0%	28.6%	0.0%	0.0%	0.0%	100.0%
		3.8%	0.0%	1.1%	0.0%	0.0%	0.0%	1.8%
		1.3%	0.0%	0.5%	0.0%	0.0%	0.0%	1.8%
Unknown	3	0	10	1	0	8	22	
	13.6%	0.0%	45.5%	4.5%	0.0%	36.4%	100.0%	
	2.3%	0.0%	5.3%	3.8%	0.0%	30.8%	5.6%	
	0.8%	0.0%	2.5%	0.3%	0.0%	2.0%	5.6%	
Total	133	18	190	26	2	26	395	
	33.7%	4.6%	48.1%	6.6%	0.5%	6.6%	100.0%	
	100.0%	100.0%	100.0%	100.0%	100.0%	100.0%	100.0%	
	33.7%	4.6%	48.1%	6.6%	0.5%	6.6%	100.0%	

Note: There were 526 cases in which the rider did not sustain a head injury.

Table C.30: Distribution of rider neck MAIS by collision contact code

Frequency Row Percent Column Percent Total Percent		OV	PTW	Road/ roadside	Helmet	Unknown	Total
Rider's neck MAIS	Minor	8	0	11	4	3	26
		30.8%	0.0%	42.3%	15.4%	11.5%	100.0%
		66.7%	0.0%	78.6%	80.0%	50.0%	68.4%
		21.1%	0.0%	28.9%	10.5%	7.9%	68.4%
	Moderate	2	1	2	1	0	6
		33.3%	16.7%	33.3%	16.7%	0.0%	100.0%
		16.7%	100.0%	14.3%	20.0%	0.0%	15.8%
	Serious	5.3%	2.6%	5.3%	2.6%	0.0%	15.8%
		1	0	0	0	0	1
		100.0%	0.0%	0.0%	0.0%	0.0%	100.0%
	Maximum	8.3%	0.0%	0.0%	0.0%	0.0%	2.6%
		2.6%	0.0%	0.0%	0.0%	0.0%	2.6%
		1	0	0	0	0	1
	Unknown	100.0%	0.0%	0.0%	0.0%	0.0%	100.0%
		8.3%	0.0%	0.0%	0.0%	0.0%	2.6%
		2.6%	0.0%	0.0%	0.0%	0.0%	2.6%
		0	0	1	0	3	4
	Total	0.0%	0.0%	25.0%	0.0%	75.0%	100.0%
0.0%		0.0%	7.1%	0.0%	50.0%	10.5%	
0.0%		0.0%	2.6%	0.0%	7.9%	10.5%	
12		1	14	5	6	38	
Total	31.6%	2.6%	36.8%	13.2%	15.8%	100.0%	
	100.0%	100.0%	100.0%	100.0%	100.0%	100.0%	
	31.6%	2.6%	36.8%	13.2%	15.8%	100.0%	

Note: There were 883 cases in which the rider did not sustain a neck injury

Table C.31: Distribution of rider upper extremity injury severity by collision contact code

Frequency Row Percent Column Percent Total Percent		OV	PTW	Road/ roadside	Animal or pedestrian	Unknown	Total
Rider's upper extremity MAIS	Minor	42	31	178	2	11	264
		15.9%	11.7%	67.4%	.8%	4.2%	100.0%
		34.1%	43.1%	61.0%	100.0%	42.3%	51.3%
		8.2%	6.0%	34.6%	0.4%	2.1%	51.3%
	Moderate	61	37	99	0	9	206
		29.6%	18.0%	48.1%	0.0%	4.4%	100.0%
		49.6%	51.4%	33.9%	0.0%	34.6%	40.0%
		11.8%	7.2%	19.2%	0.0%	1.7%	40.0%
	Serious	20	4	14	0	1	39
		51.3%	10.3%	35.9%	0.0%	2.6%	100.0%
		16.3%	5.6%	4.8%	0.0%	3.8%	7.6%
		3.9%	.8%	2.7%	0.0%	0.2%	7.6%
	Unknown	0	0	1	0	5	6
		0.0%	0.0%	16.7%	0.0%	83.3%	100.0%
		0.0%	0.0%	0.3%	0.0%	19.2%	1.2%
0.0%		0.0%	0.2%	0.0%	1.0%	1.2%	
Total	123	72	292	2	26	515	
	23.9%	14.0%	56.7%	0.4%	5.0%	100.0%	
	100.0%	100.0%	100.0%	100.0%	100.0%	100.0%	
	23.9%	14.0%	56.7%	0.4%	5.0%	100.0%	

Note: There were 406 cases in which the rider did not sustain an upper extremity injury

Table C.32: Distribution of rider thoracic MAIS by collision contact code

Frequency Row Percent Column Percent Total Percent		OV	PTW	Road/ roadside	Animal or pedestrian	Unknown	Total
Rider's maximum thoracic MAIS	Minor	18	9	49	1	2	79
		22.8%	11.4%	62.0%	1.3%	2.5%	100.0%
		27.7%	33.3%	53.8%	50.0%	18.2%	40.3%
		9.2%	4.6%	25.0%	0.5%	1.0%	40.3%
	Moderate	6	5	9	0	0	20
		30.0%	25.0%	45.0%	0.0%	0.0%	100.0%
		9.2%	18.5%	9.9%	0.0%	0.0%	10.2%
		3.1%	2.6%	4.6%	0.0%	0.0%	10.2%
	Serious	15	3	11	0	3	32
		46.9%	9.4%	34.4%	0.0%	9.4%	100.0%
		23.1%	11.1%	12.1%	0.0%	27.3%	16.3%
		7.7%	1.5%	5.6%	0.0%	1.5%	16.3%
	Severe	18	5	9	0	1	33
		54.5%	15.2%	27.3%	0.0%	3.0%	100.0%
		27.7%	18.5%	9.9%	0.0%	9.1%	16.8%
		9.2%	2.6%	4.6%	0.0%	0.5%	16.8%
	Critical	3	1	5	0	0	9
		33.3%	11.1%	55.6%	0.0%	0.0%	100.0%
		4.6%	3.7%	5.5%	0.0%	0.0%	4.6%
		1.5%	0.5%	2.6%	0.0%	0.0%	4.6%
	Maximum	3	2	1	1	0	7
		42.9%	28.6%	14.3%	14.3%	0.0%	100.0%
		4.6%	7.4%	1.1%	50.0%	0.0%	3.6%
		1.5%	1.0%	0.5%	0.5%	0.0%	3.6%
	Unknown	2	2	7	0	5	16
		12.5%	12.5%	43.8%	0.0%	31.3%	100.0%
		3.1%	7.4%	7.7%	0.0%	45.5%	8.2%
1.0%		1.0%	3.6%	0.0%	2.6%	8.2%	
Total	65	27	91	2	11	196	
	33.2%	13.8%	46.4%	1.0%	5.6%	100.0%	
	100.0%	100.0%	100.0%	100.0%	100.0%	100.0%	
	33.2%	13.8%	46.4%	1.0%	5.6%	100.0%	

Note: There were 725 cases in which the rider did not sustain a thoracic injury

Table C.33: Distribution of rider abdominal MAIS by collision contact code

Frequency Row Percent Column Percent Total Percent		OV	PTW	Road/ roadside	Unknown	Total
Rider's abdomen MAIS	Minor	7	15	23	3	48
		14.6%	31.3%	47.9%	6.3%	100.0%
		26.9%	50.0%	56.1%	27.3%	44.4%
		6.5%	13.9%	21.3%	2.8%	44.4%
	Moderate	4	4	7	0	15
		26.7%	26.7%	46.7%	0.0%	100.0%
		15.4%	13.3%	17.1%	0.0%	13.9%
	Serious	3.7%	3.7%	6.5%	0.0%	13.9%
		6	5	1	1	13
		46.2%	38.5%	7.7%	7.7%	100.0%
	Severe	23.1%	16.7%	2.4%	9.1%	12.0%
		5.6%	4.6%	0.9%	0.9%	12.0%
		3	1	0	1	5
	Critical	60.0%	20.0%	0.0%	20.0%	100.0%
		11.5%	3.3%	0.0%	9.1%	4.6%
		2.8%	0.9%	0.0%	0.9%	4.6%
	Maximum	4	1	6	0	11
		36.4%	9.1%	54.5%	0.0%	100.0%
		15.4%	3.3%	14.6%	0.0%	10.2%
	Unknown	3.7%	0.9%	5.6%	0.0%	10.2%
1		0	0	0	1	
100.0%		0.0%	0.0%	0.0%	100.0%	
Total	3.8%	0.0%	0.0%	0.0%	0.9%	
	0.9%	0.0%	0.0%	0.0%	0.9%	
	1	4	4	6	15	
Total	Unknown	6.7%	26.7%	26.7%	40.0%	100.0%
		3.8%	13.3%	9.8%	54.5%	13.9%
		.9%	3.7%	3.7%	5.6%	13.9%
		26	30	41	11	108
Total	Total	24.1%	27.8%	38.0%	10.2%	100.0%
		100.0%	100.0%	100.0%	100.0%	100.0%
		24.1%	27.8%	38.0%	10.2%	100.0%
		24.1%	27.8%	38.0%	10.2%	100.0%

Note: There were 813 cases in which the rider did not sustain an abdominal injury

Table C.34: Distribution of rider pelvic MAIS by collision contact code

Frequency Row Percent Column Percent Total Percent		OV	PTW	Road/ roadside	Unknown	Total
Rider's pelvis MAIS	Minor	4	6	14	0	24
		16.7%	25.0%	58.3%	0.0%	100.0%
		33.3%	27.3%	50.0%	0.0%	34.8%
		5.8%	8.7%	20.3%	0.0%	34.8%
	Moderate	3	8	10	2	23
		13.0%	34.8%	43.5%	8.7%	100.0%
		25.0%	36.4%	35.7%	28.6%	33.3%
		4.3%	11.6%	14.5%	2.9%	33.3%
	Serious	4	6	1	0	11
		36.4%	54.5%	9.1%	0.0%	100.0%
		33.3%	27.3%	3.6%	0.0%	15.9%
		5.8%	8.7%	1.4%	0.0%	15.9%
	Severe	1	0	2	0	3
		33.3%	0.0%	66.7%	0.0%	100.0%
		8.3%	0.0%	7.1%	0.0%	4.3%
		1.4%	0.0%	2.9%	0.0%	4.3%
Unknown	0	2	1	5	8	
	0.0%	25.0%	12.5%	62.5%	100.0%	
	0.0%	9.1%	3.6%	71.4%	11.6%	
	0.0%	2.9%	1.4%	7.2%	11.6%	
Total	12	22	28	7	69	
	17.4%	31.9%	40.6%	10.1%	100.0%	
	100.0%	100.0%	100.0%	100.0%	100.0%	
	17.4%	31.9%	40.6%	10.1%	100.0%	

Note: There were 852 cases in which the rider did not sustain a pelvic injury

Table C.35: Distribution of rider spine MAIS by collision contact code

Frequency Row Percent Column Percent Total Percent		OV	PTW	Road/ roadside	Unknown	Total
Rider's spine MAIS	Minor	16	2	38	2	58
		27.6%	3.4%	65.5%	3.4%	100.0%
		44.4%	50.0%	53.5%	15.4%	46.8%
		12.9%	1.6%	30.6%	1.6%	46.8%
	Moderate	8	1	18	3	30
		26.7%	3.3%	60.0%	10.0%	100.0%
		22.2%	25.0%	25.4%	23.1%	24.2%
		6.5%	0.8%	14.5%	2.4%	24.2%
	Serious	0	0	3	2	5
		0.0%	0.0%	60.0%	40.0%	100.0%
		0.0%	0.0%	4.2%	15.4%	4.0%
		0.0%	0.0%	2.4%	1.6%	4.0%
	Severe	1	0	0	0	1
		100.0%	0.0%	0.0%	0.0%	100.0%
		2.8%	0.0%	0.0%	0.0%	0.8%
		0.8%	0.0%	0.0%	0.0%	0.8%
	Critical	2	1	5	0	8
		25.0%	12.5%	62.5%	0.0%	100.0%
		5.6%	25.0%	7.0%	0.0%	6.5%
		1.6%	0.8%	4.0%	0.0%	6.5%
	Maximum	7	0	3	0	10
		70.0%	0.0%	30.0%	0.0%	100.0%
		19.4%	0.0%	4.2%	0.0%	8.1%
		5.6%	0.0%	2.4%	0.0%	8.1%
Unknown	2	0	4	6	12	
	16.7%	0.0%	33.3%	50.0%	100.0%	
	5.6%	0.0%	5.6%	46.2%	9.7%	
	1.6%	0.0%	3.2%	4.8%	9.7%	
Total	36	4	71	13	124	
	29.0%	3.2%	57.3%	10.5%	100.0%	
	100.0%	100.0%	100.0%	100.0%	100.0%	
	29.0%	3.2%	57.3%	10.5%	100.0%	

Note: There were 797 cases in which the rider did not sustain a spinal injury

Table C.36: Distribution of rider lower extremity MAIS injury by collision contact code

Frequency Row Percent Column Percent Total Percent		OV	PTW	Road/ roadside	Animal pedestrian	or Unknown	Total
Rider's lower extremity MAIS	Minor	76	77	200	0	10	363
		20.9%	21.2%	55.1%	0.0%	2.8%	100.0%
		38.6%	45.6%	69.7%	0.0%	38.5%	53.4%
		11.2%	11.3%	29.4%	0.0%	1.5%	53.4%
	Moderate	59	44	47	0	8	158
		37.3%	27.8%	29.7%	0.0%	5.1%	100.0%
		29.9%	26.0%	16.4%	0.0%	30.8%	23.2%
		8.7%	6.5%	6.9%	0.0%	1.2%	23.2%
	Serious	58	48	35	1	1	143
		40.6%	33.6%	24.5%	0.7%	0.7%	100.0%
		29.4%	28.4%	12.2%	100.0%	3.8%	21.0%
		8.5%	7.1%	5.1%	0.1%	0.1%	21.0%
	Severe	2	0	1	0	0	3
		66.7%	0.0%	33.3%	0.0%	0.0%	100.0%
		1.0%	0.0%	0.3%	0.0%	0.0%	0.4%
		0.3%	0.0%	0.1%	0.0%	0.0%	0.4%
	Critical	1	0	1	0	0	2
		50.0%	0.0%	50.0%	0.0%	0.0%	100.0%
		0.5%	0.0%	0.3%	0.0%	0.0%	0.3%
		0.1%	0.0%	0.1%	0.0%	0.0%	0.3%
Unknown	1	0	3	0	7	11	
	9.1%	0.0%	27.3%	0.0%	63.6%	100.0%	
	0.5%	0.0%	1.0%	0.0%	26.9%	1.6%	
	0.1%	0.0%	0.4%	0.0%	1.0%	1.6%	
Total	197	169	287	1	26	680	
	29.0%	24.9%	42.2%	0.1%	3.8%	100.0%	
	100.0%	100.0%	100.0%	100.0%	100.0%	100.0%	
	29.0%	24.9%	42.2%	0.1%	3.8%	100.0%	

Note: There were 241 cases in which the rider did not sustain a lower extremity injury

Table C.37: Cross-tabulation of passenger MAIS by body region

Frequency Row Percent Column Percent Total Percent		AIS						
		MINOR	MODERATE	SERIOUS	SEVERE	CRITICAL		MAXIMUM
Body region	HEAD	8	14	3	1	1	1	28
		28.6%	50.0%	10.7%	3.6%	3.6%	3.6%	100.0%
		11.0%	41.2%	21.4%	50.0%	100.0%	50.0%	22.2%
		6.3%	11.1%	2.4%	0.8%	0.8%	0.8%	22.2%
	NECK	0	0	0	0	0	0	0
		0.0%	0.0%	0.0%	0.0%	0.0%	0.0%	0.0%
		0.0%	0.0%	0.0%	0.0%	0.0%	0.0%	0.0%
		0.0%	0.0%	0.0%	0.0%	0.0%	0.0%	0.0%
	THORAX	4	1	1	1	0	0	7
		57.1%	14.3%	14.3%	14.3%	0.0%	0.0%	100.0%
		5.5%	2.9%	7.1%	100.0%	0.0%	0.0%	5.6%
		3.2%	0.8%	0.8%	0.8%	0.0%	0.0%	5.6%
	UPPER EX	22	7	0	0	0	0	29
		75.9%	24.1%	0.0%	0.0%	0.0%	0.0%	100.0%
		30.1%	20.6%	0.0%	0.0%	0.0%	0.0%	23.0%
		17.5%	5.6%	0.0%	0.0%	0.0%	0.0%	23.0%
	ABDOMEN	4	1	1	0	0	0	6
		66.7%	16.7%	16.7%	0.0%	0.0%	0.0%	100.0%
		5.5%	2.9%	7.1%	0.0%	0.0%	0.0%	4.8%
		3.2%	0.8%	0.8%	0.0%	0.0%	0.0%	4.8%
	SPINE	8	0	0	0	0	1	9
		88.9%	0.0%	0.0%	0.0%	0.0%	11.1%	100.0%
		11.0%	0.0%	0.0%	0.0%	0.0%	50.0%	7.1%
		6.3%	0.0%	0.0%	0.0%	0.0%	0.8%	7.1%
	PELVIS	0	3	0	0	0	0	3
		0.0%	100.0%	0.0%	0.0%	0.0%	0.0%	100.0%
		0.0%	8.8%	0.0%	0.0%	0.0%	0.0%	2.4%
		0.0%	2.4%	0.0%	0.0%	0.0%	0.0%	2.4%
	LOWER EX	21	8	9	0	0	0	38
		55.3%	21.1%	23.7%	0.0%	0.0%	0.0%	100.0%
		28.8%	23.5%	64.3%	0.0%	0.0%	0.0%	30.2%
		16.7%	6.3%	7.1%	0.0%	0.0%	0.0%	30.2%
	WHOLE BODY	6	0	0	0	0	0	6
		100.0%	0.0%	0.0%	0.0%	0.0%	0.0%	100.0%
		8.2%	0.0%	0.0%	0.0%	0.0%	0.0%	4.8%
		4.8%	0.0%	0.0%	0.0%	0.0%	0.0%	4.8%
	Total	73	34	14	2	1	2	126
		57.9%	27.0%	11.1%	1.6%	0.8%	1.6%	100.0%
		100.0%	100.0%	100.0%	100.0%	100.0%	100.0%	100.0%
		57.9%	27.0%	11.1%	1.6%	0.8%	1.6%	100.0%

Figure C.38: Cross-tabulation of rider MAIS by PTW impact speed

Frequency Row Percent Column Percent Total Percent		PTW impact speed					Total
		0 - 30 km/h	31 - 50 km/h	51- 60 km/h	>61 km/h	Unknown	
PTW rider MAIS	No injury to PTW rider	5	4	2	4	0	15
		33.3%	26.7%	13.3%	26.7%	0.0%	100.0%
		1.6%	1.2%	2.1%	2.2%	0.0%	0.8%
		0.5%	0.4%	0.2%	0.4%	0.0%	1.6%
	Minor	167	120	20	22	1	330
		50.6%	36.4%	6.1%	6.7%	0.3%	100.0%
		53.2%	36.4%	21.1%	12.2%	50.0%	17.9%
		18.1%	13.0%	2.2%	2.4%	0.1%	35.8%
	Moderate	99	122	29	56	1	307
		32.2%	39.7%	9.4%	18.2%	0.3%	100.0%
		31.5%	37.0%	30.5%	31.1%	50.0%	16.7%
		10.7%	13.2%	3.1%	6.1%	0.1%	33.3%
	Serious	31	44	28	40	0	143
		21.7%	30.8%	19.6%	28.0%	0.0%	100.0%
		9.9%	13.3%	29.5%	22.2%	0.0%	7.8%
		3.4%	4.8%	3.0%	4.3%	0.0%	15.5%
	Severe	3	12	6	17	0	38
		7.9%	31.6%	15.8%	44.7%	0.0%	100.0%
		1.0%	3.6%	6.3%	9.4%	0.0%	2.1%
		0.3%	1.3%	0.7%	1.8%	0.0%	4.1%
	Critical	7	14	5	17	0	43
		16.3%	32.6%	11.6%	39.5%	0.0%	100.0%
		2.2%	4.2%	5.3%	9.4%	0.0%	2.3%
		0.8%	1.5%	0.5%	1.8%	0.0%	4.7%
	Maximum	1	6	2	8	0	17
		5.9%	35.3%	11.8%	47.1%	0.0%	100.0%
		0.3%	1.8%	2.1%	4.4%	0.0%	0.9%
		0.1%	0.7%	0.2%	0.9%	0.0%	1.8%
	Unknown MAIS	1	8	3	16	0	28
		3.6%	28.6%	10.7%	57.1%	0.0%	100.0%
		0.3%	2.4%	3.2%	8.9%	0.0%	1.5%
		0.1%	0.9%	0.3%	1.7%	0.0%	3.0%
	Total	314	330	95	180	2	921
17.0%		17.9%	5.2%	9.8%	0.1%	100.0%	
100.0%		100.0%	100.0%	100.0%	100.0%	100.0%	
17.0%		17.9%	5.2%	9.8%	0.1%	100.0%	

Table C.39: Cross-tabulation of helmeted rider's head MAIS and PTW impact speed

Frequency Row Percent Column Percent Total Percent		PTW impact speed				Total
		0 - 30 km/h	31 - 50 km/h	51- 60 km/h	>61 km/h	
Rider's head max, abbreviated injury scale	No injury	188	196	55	117	556
		33.8%	35.3%	9.9%	21.0%	100.0%
		76.7%	68.1%	64.7%	67.6%	70.3%
		23.8%	24.8%	7.0%	14.8%	70.3%
	Minor	26	30	7	10	73
		35.6%	41.1%	9.6%	13.7%	100.0%
		10.6%	10.4%	8.2%	5.8%	9.2%
		3.3%	3.8%	0.9%	1.3%	9.2%
	Moderate	24	40	12	21	97
		24.7%	41.2%	12.4%	21.6%	100.0%
		9.8%	13.9%	14.1%	12.1%	12.3%
		3.0%	5.1%	1.5%	2.7%	12.3%
	Serious	3	11	5	10	29
		10.3%	37.9%	17.2%	34.5%	100.0%
		1.2%	3.8%	5.9%	5.8%	3.7%
		0.4%	1.4%	0.6%	1.3%	3.7%
	Severe	0	5	5	5	15
		0.0%	33.3%	33.3%	33.3%	100.0%
		0.0%	1.7%	5.9%	2.9%	1.9%
		0.0%	0.6%	0.6%	0.6%	1.9%
	Critical	4	4	1	9	18
		22.2%	22.2%	5.6%	50.0%	100.0%
		1.6%	1.4%	1.2%	5.2%	2.3%
		0.5%	0.5%	0.1%	1.1%	2.3%
Maximum	0	2	0	1	3	
	0.0%	66.7%	0.0%	33.3%	100.0%	
	0.0%	0.7%	0.0%	0.6%	0.4%	
	0.0%	0.3%	0.0%	0.1%	0.4%	
Total	245	288	85	173	791	
	31.0%	36.4%	10.7%	21.9%	100.0%	
	100.0%	100.0%	100.0%	100.0%	100.0%	
	31.0%	36.4%	10.7%	21.9%	100.0%	